

अक्षर लेखन

म

क

ह

अ

स

आ

है

ख



दिनांक: ___/___/___

कक्षा कार्य / गृह कार्य

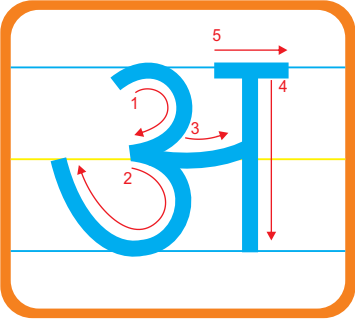

चित्र देखकर रंग भरिए।

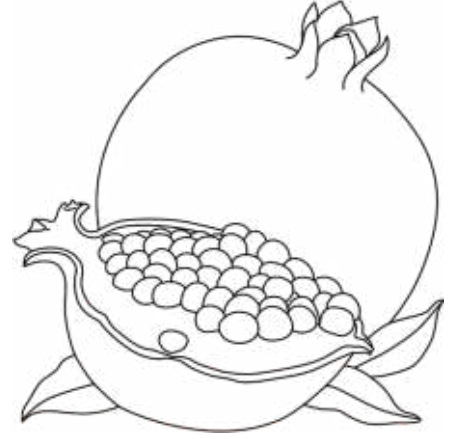

अनार

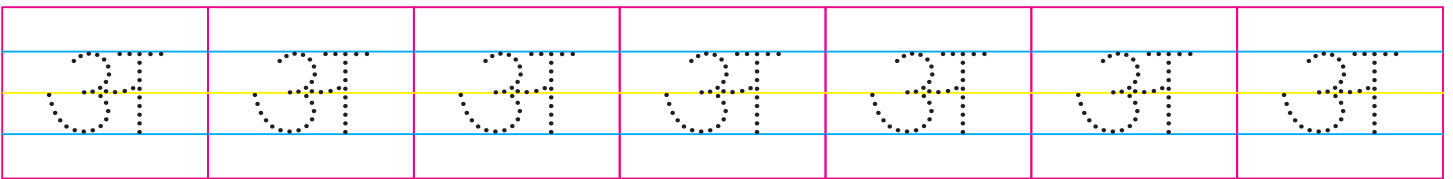
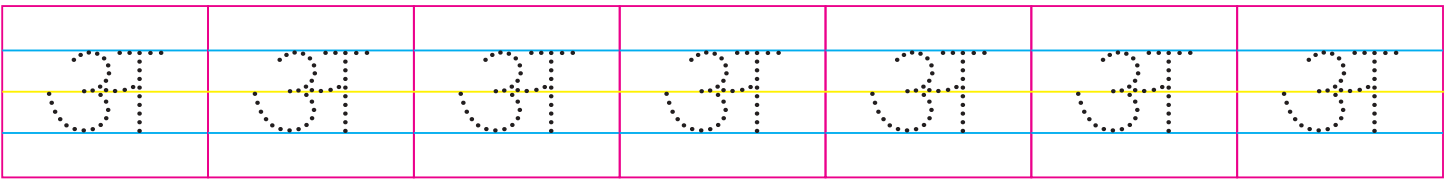
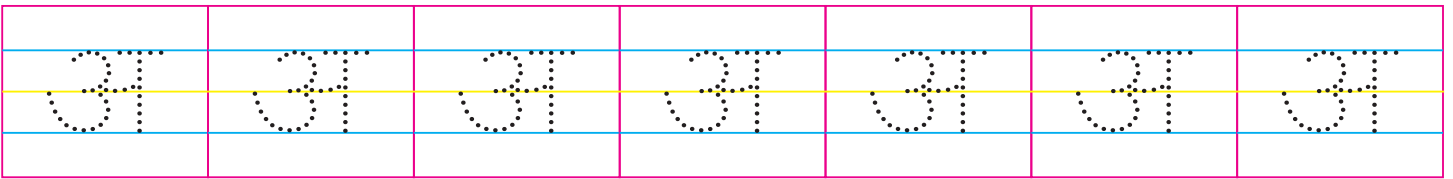
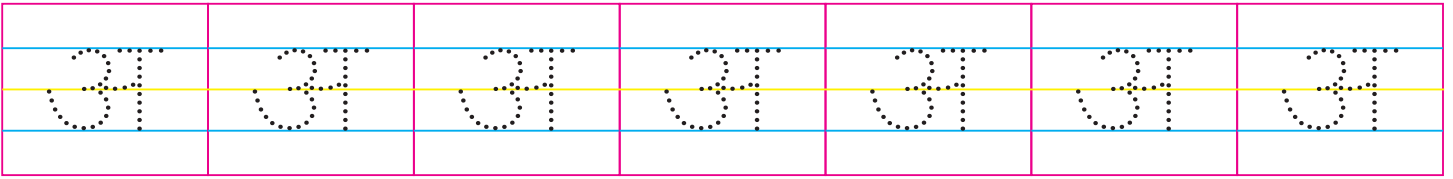
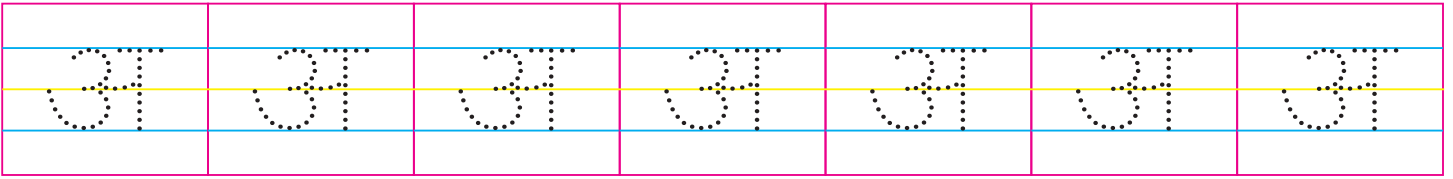
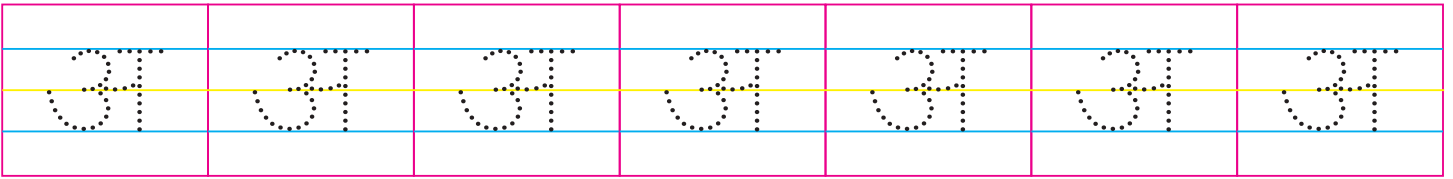
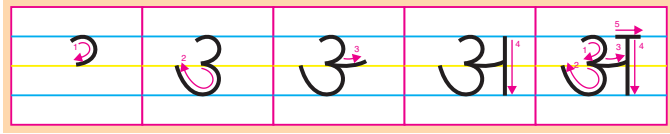

हस्ताक्षर :

दिनांक: ___/___/___

कक्षा कार्य / गृह कार्य

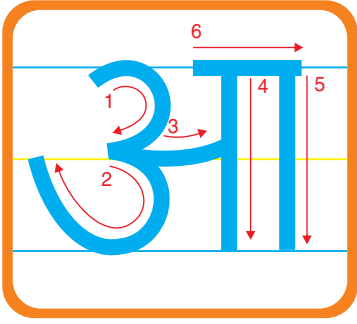

आम

चित्र देखकर रंग भरिए।

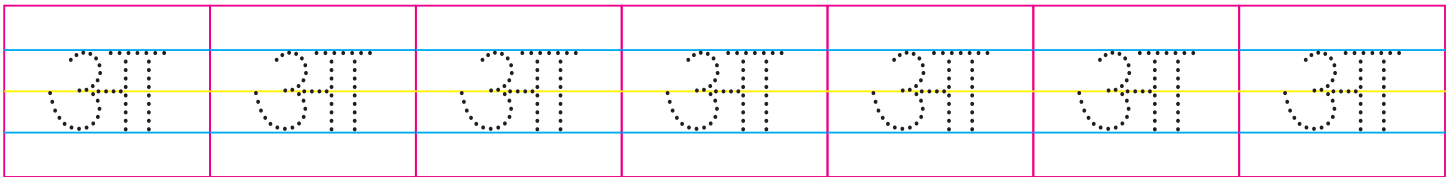
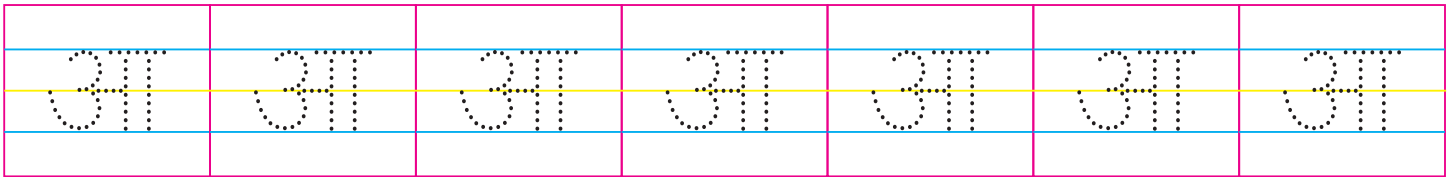
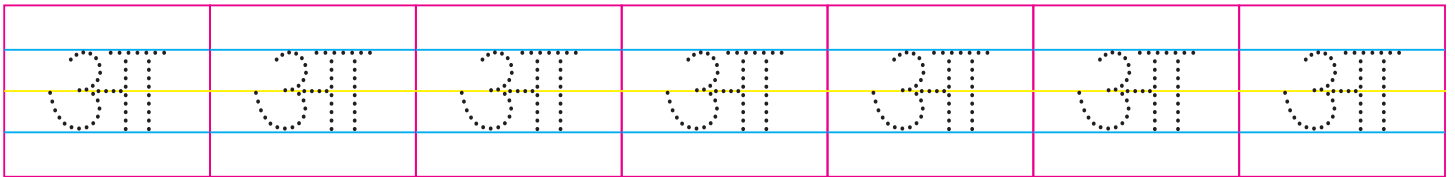
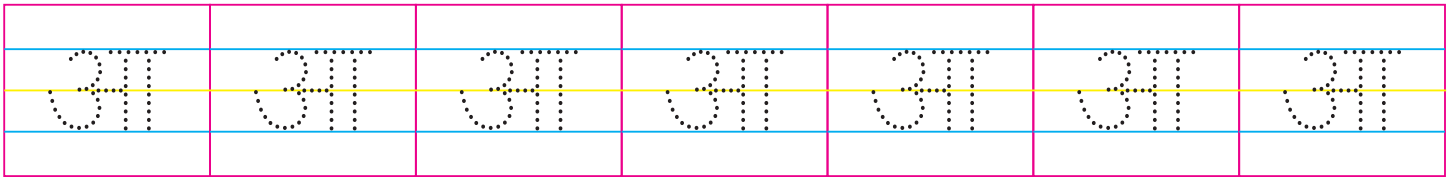
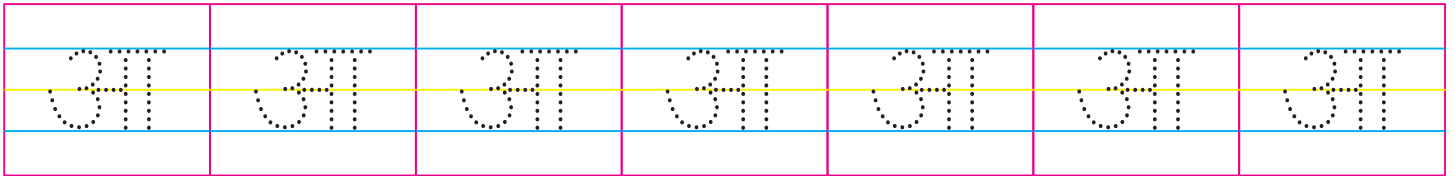
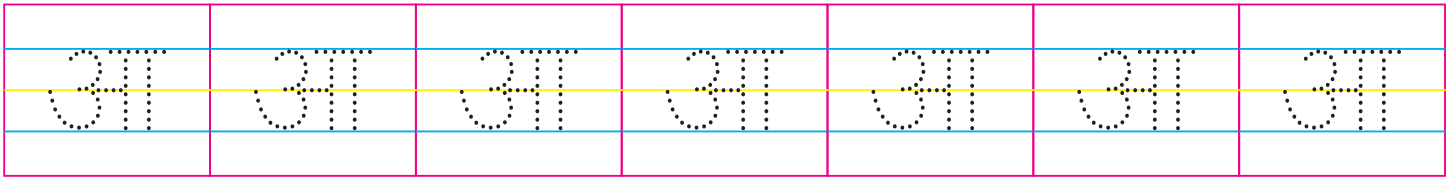
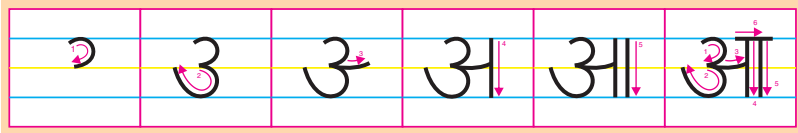

हस्ताक्षर :

दिनांक: ___/___/___

कक्षा कार्य / गृह कार्य

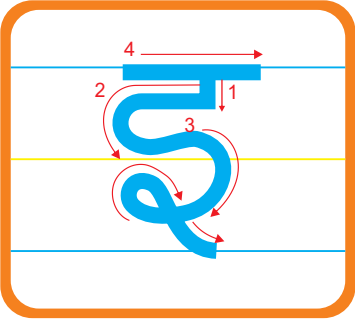

चित्र देखकर रंग भरिए-

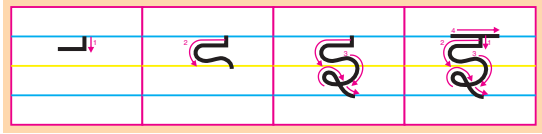
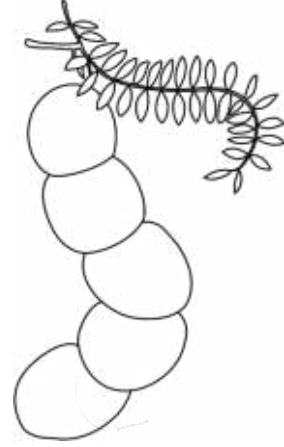

इमली

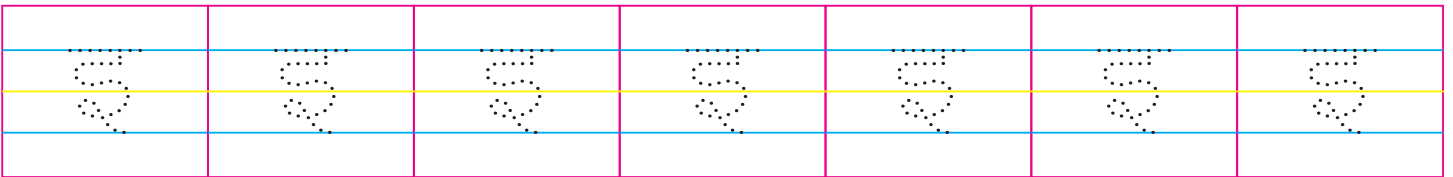
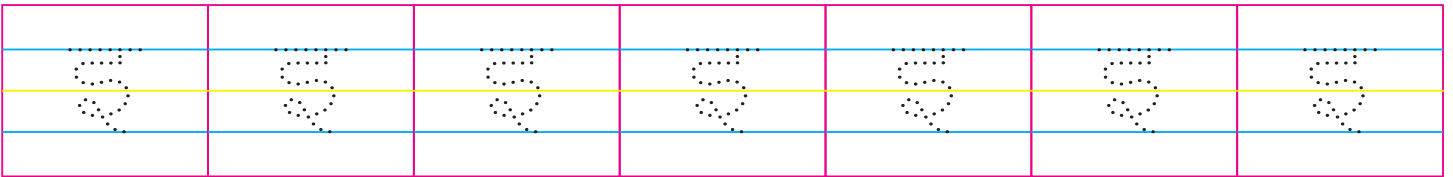
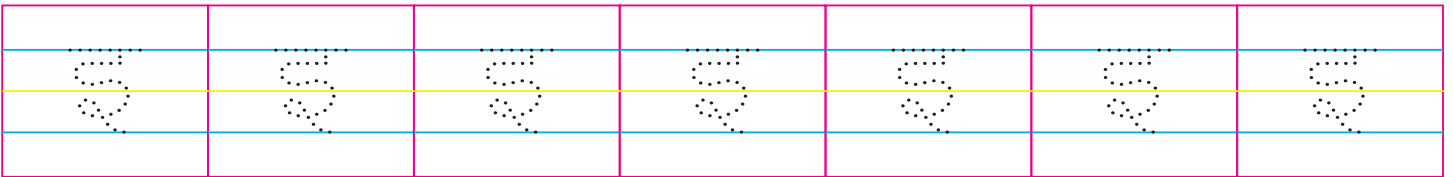
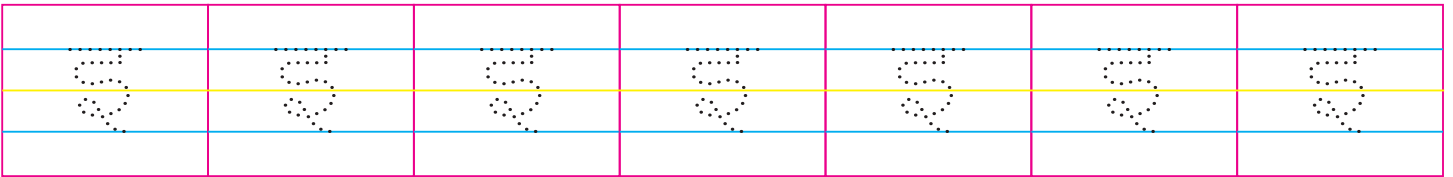
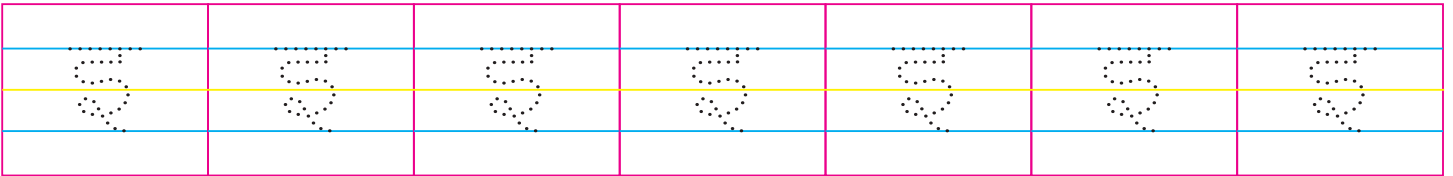
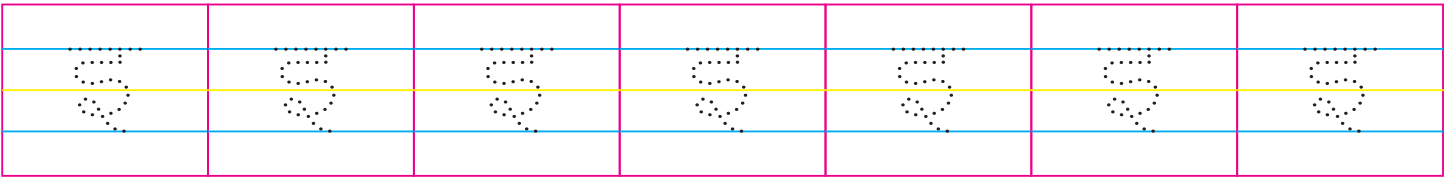

हस्ताक्षर :

दिनांक: ___ / ___ / ___

कक्षा कार्य / गृह कार्य

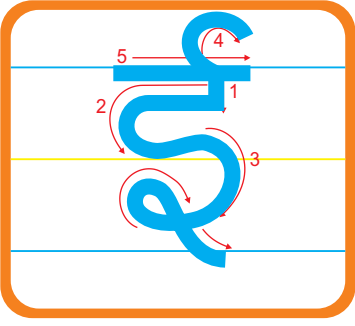

ईख

चित्र देखकर रंग भरिए-

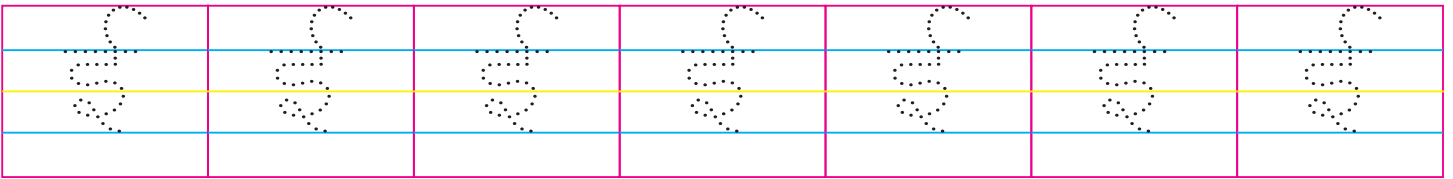
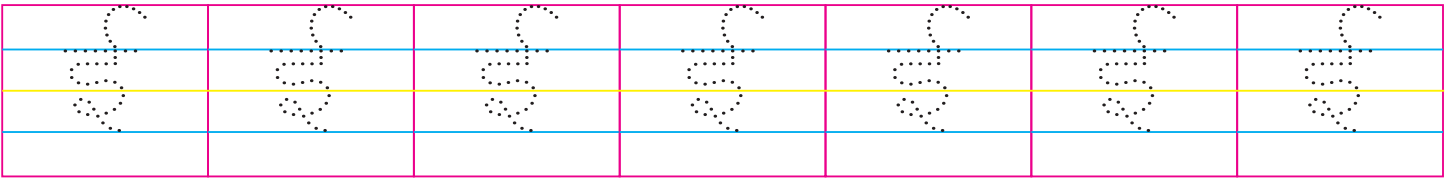
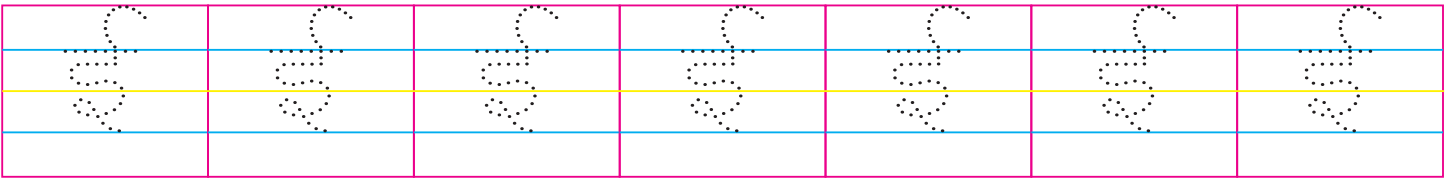
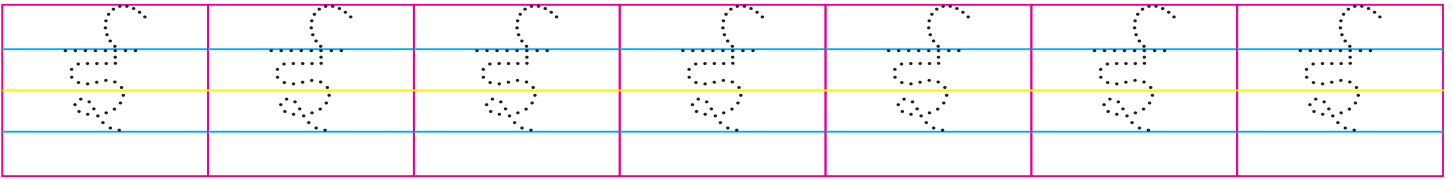
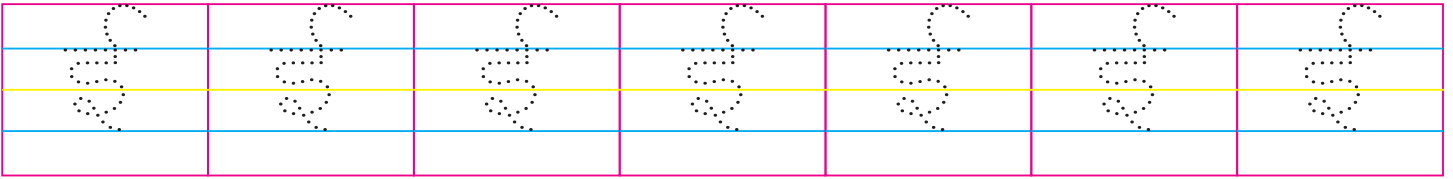
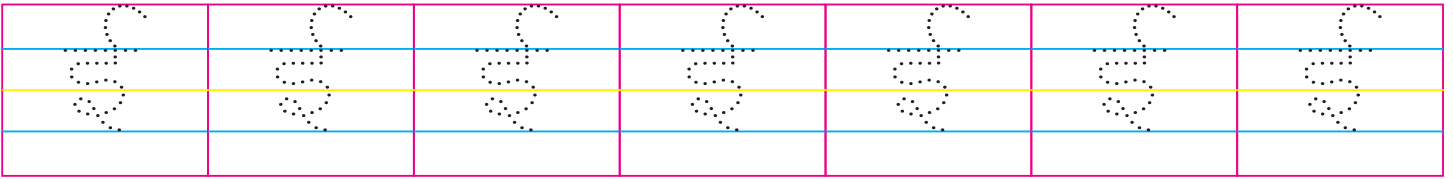
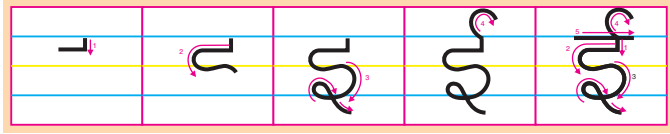
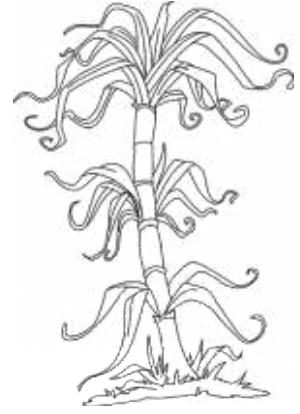

हस्ताक्षर :

दिनांक: ___/___/___

कक्षा कार्य / गृह कार्य

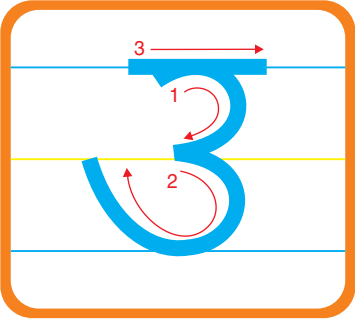

उल्लू

चित्र देखकर रंग भरिए-

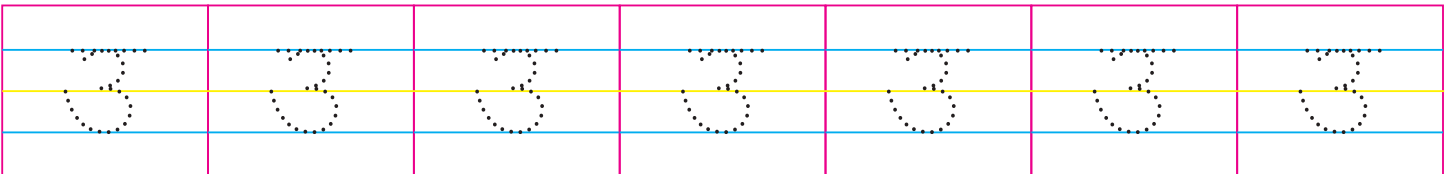
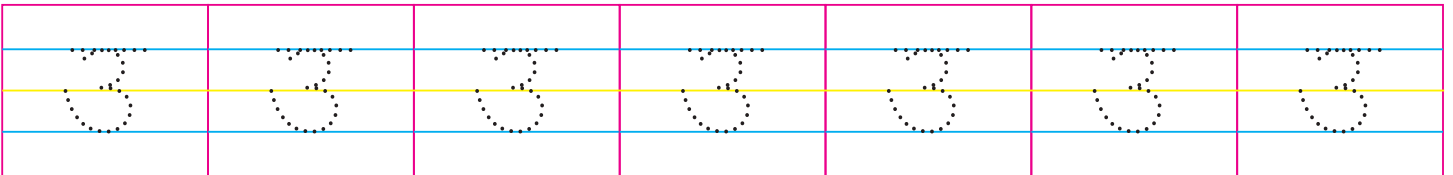
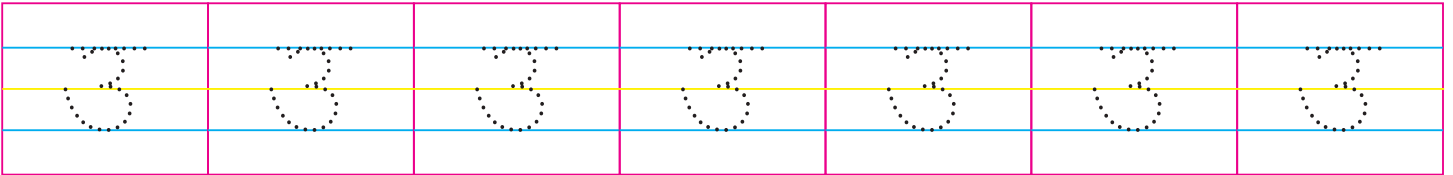
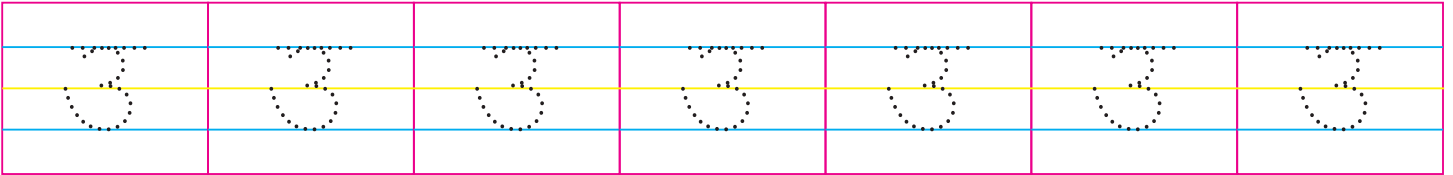
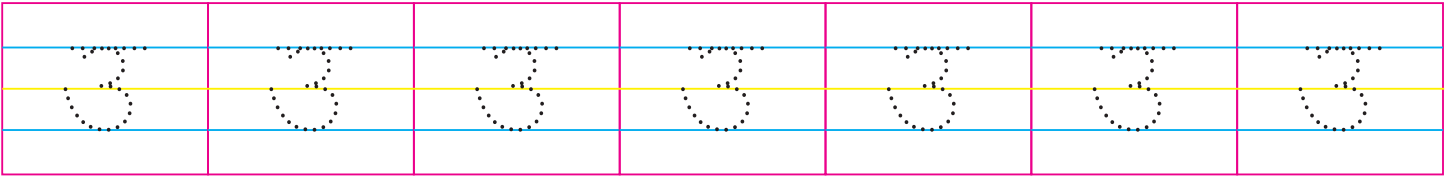
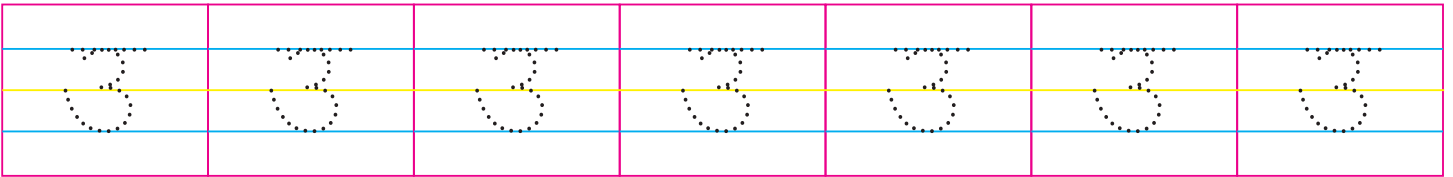
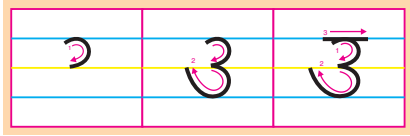

हस्ताक्षर :

दिनांक: ___/___/___

कक्षा कार्य / गृह कार्य

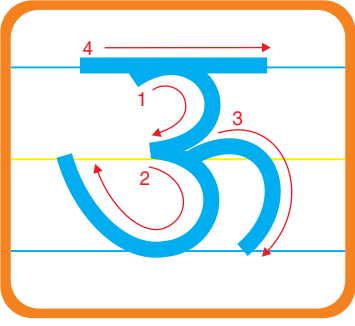

चित्र देखकर रंग भरिए-

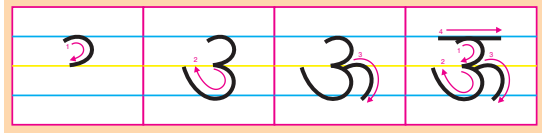
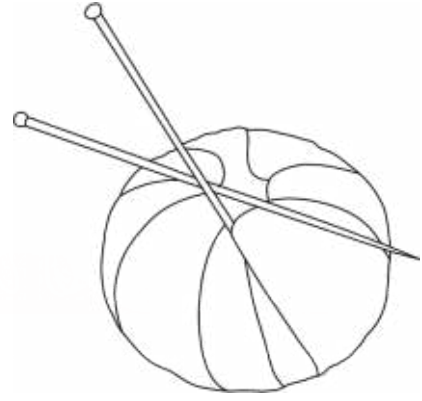

ऊन

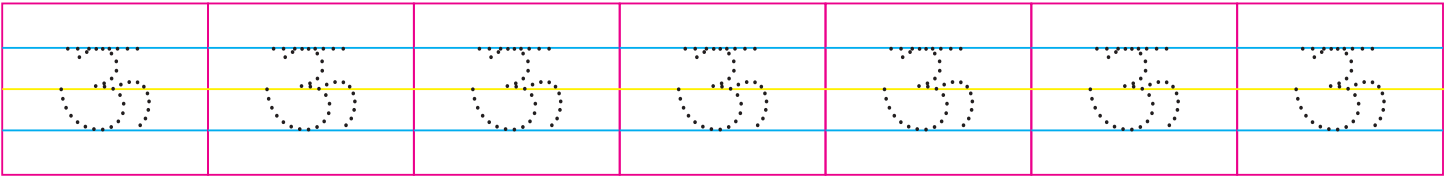
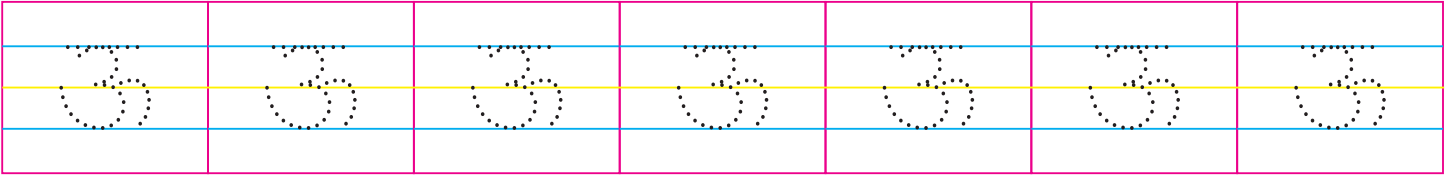
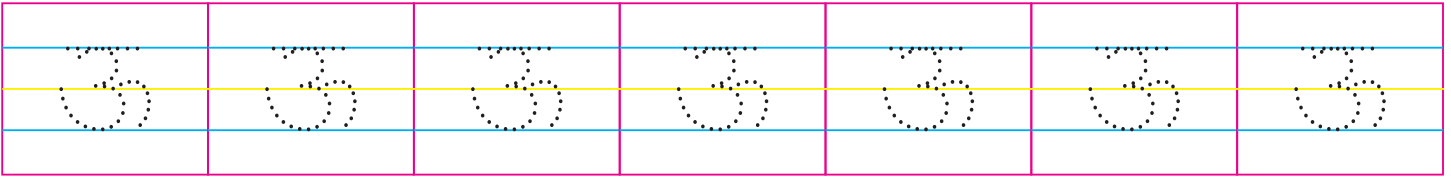
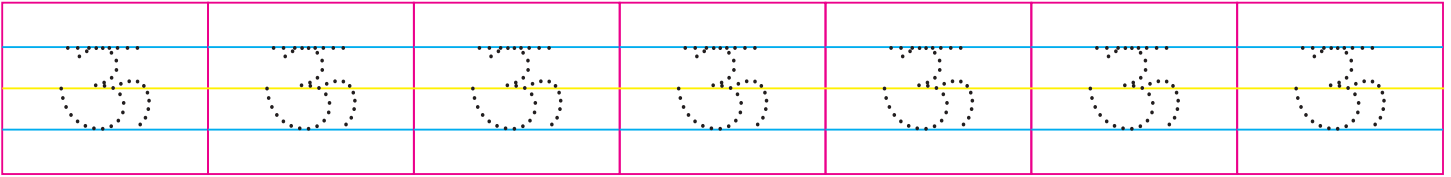
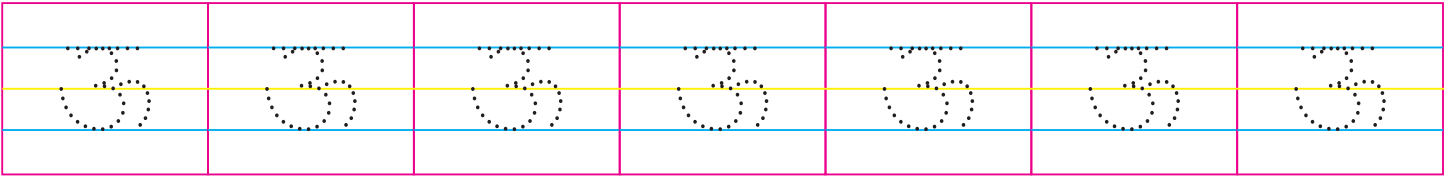
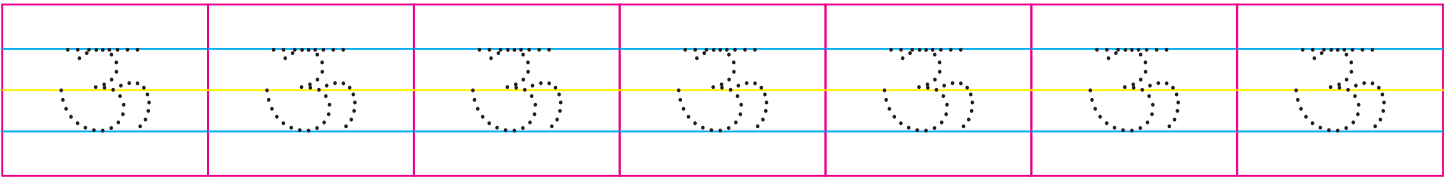

हस्ताक्षर :

दिनांक: ___/___/___

कक्षा कार्य / गृह कार्य

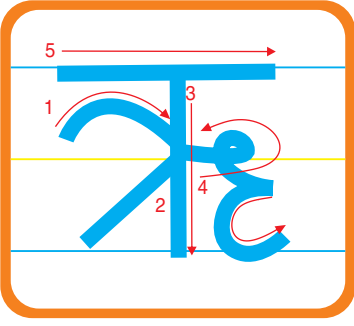

ऋषि



चित्र देखकर रंग भरिए-

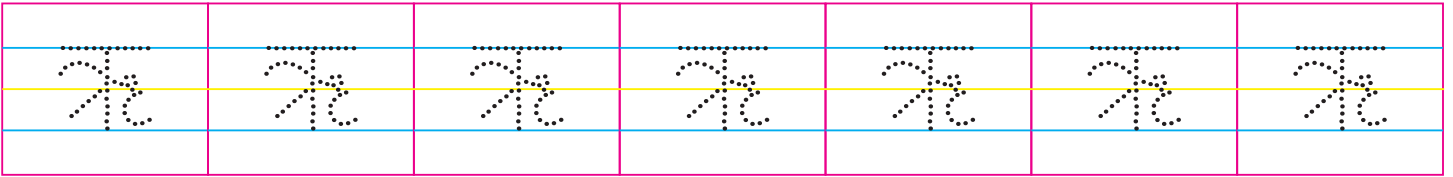
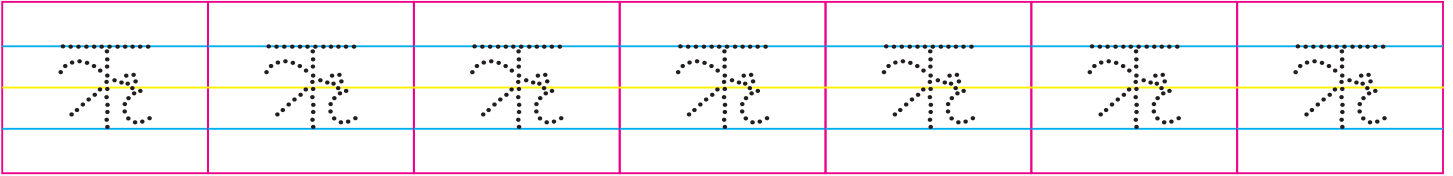
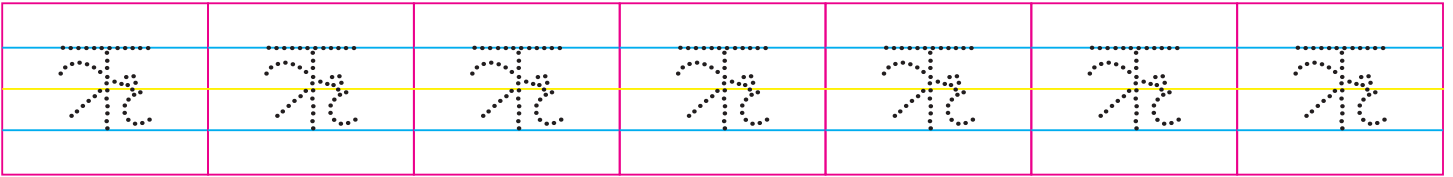
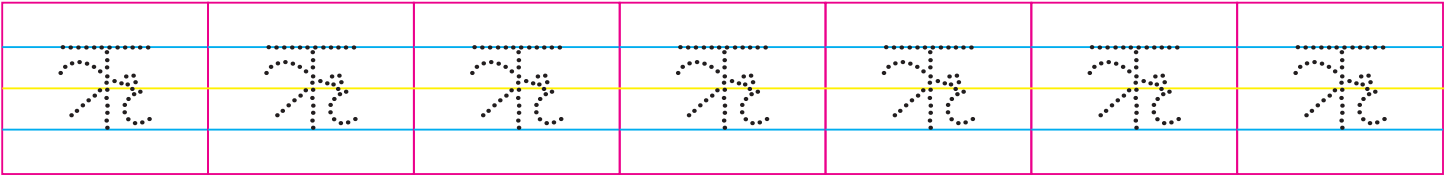
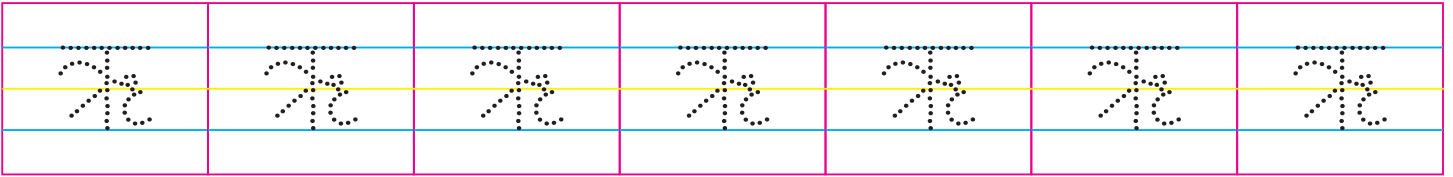
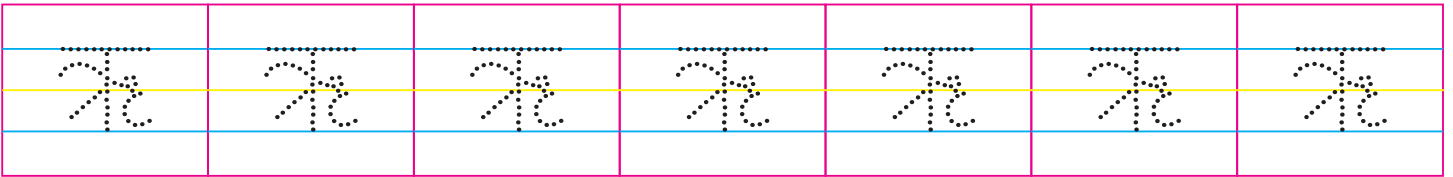
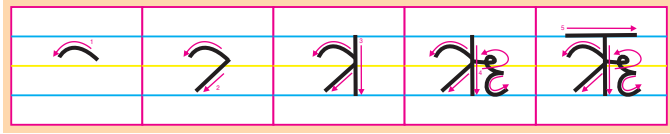

हस्ताक्षर :

दिनांक: ___/___/___

कक्षा कार्य / गृह कार्य

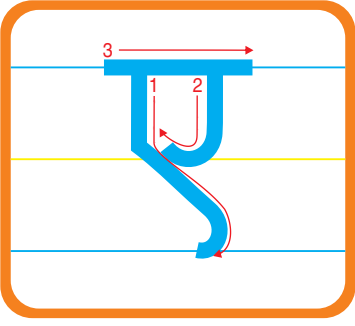

चित्र देखकर रंग भरिए-

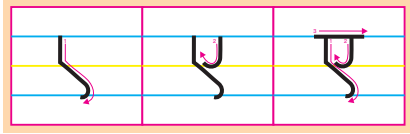

एड़ी

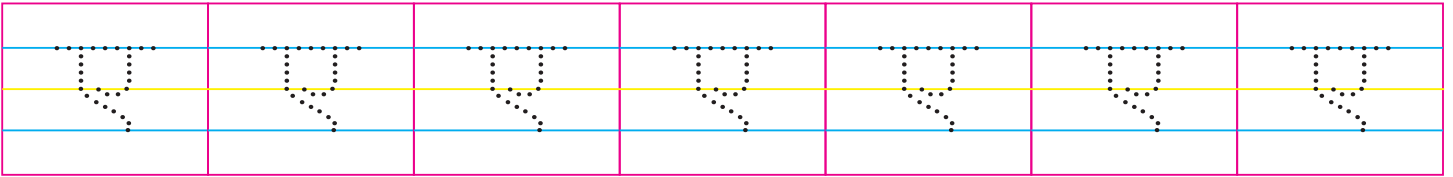
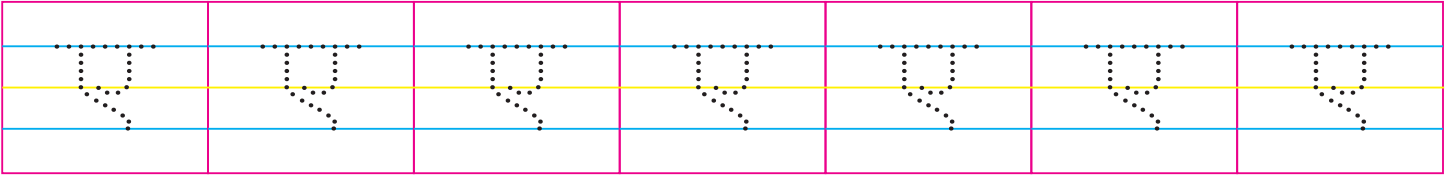
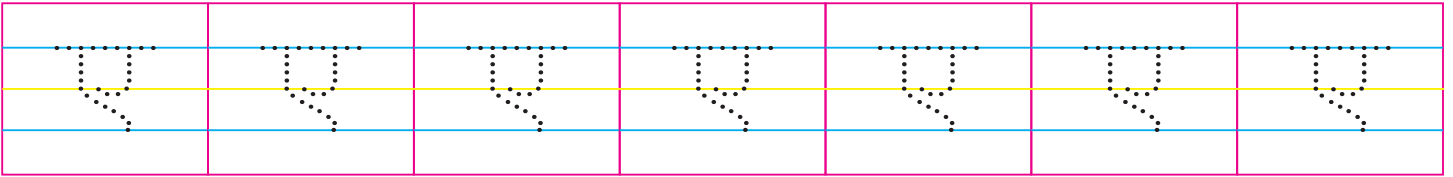
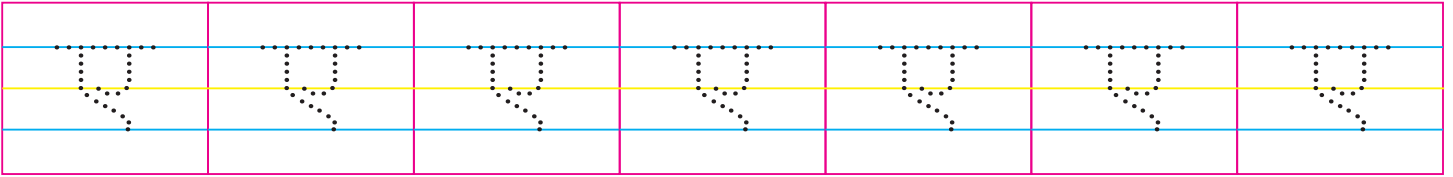
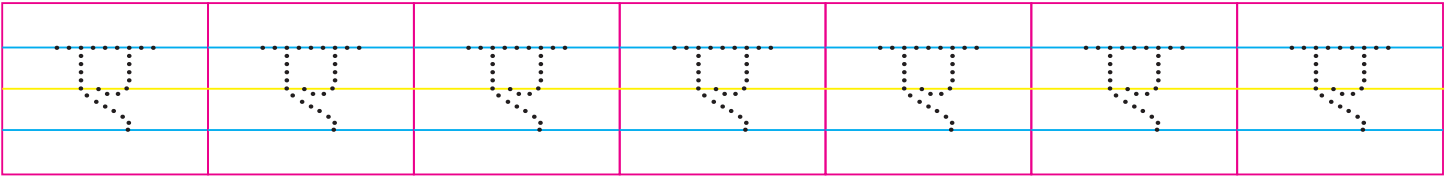
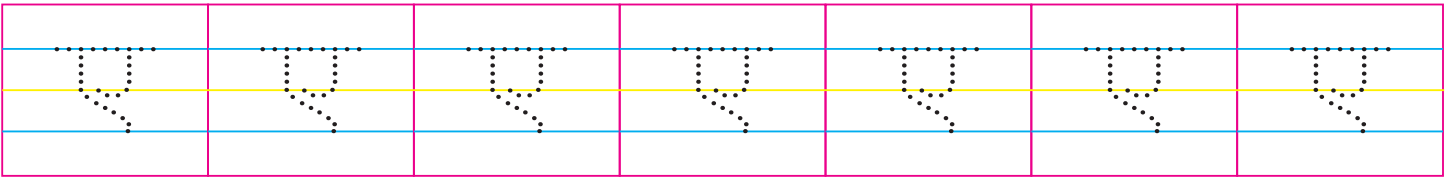

हस्ताक्षर :

दिनांक: ___/___/___

कक्षा कार्य / गृह कार्य

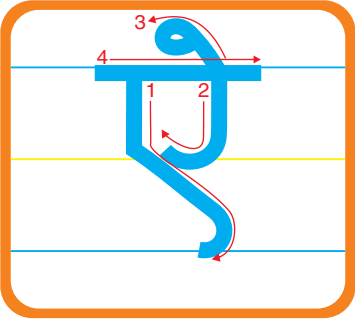

चित्र देखकर रंग भरिए-



ऐनक

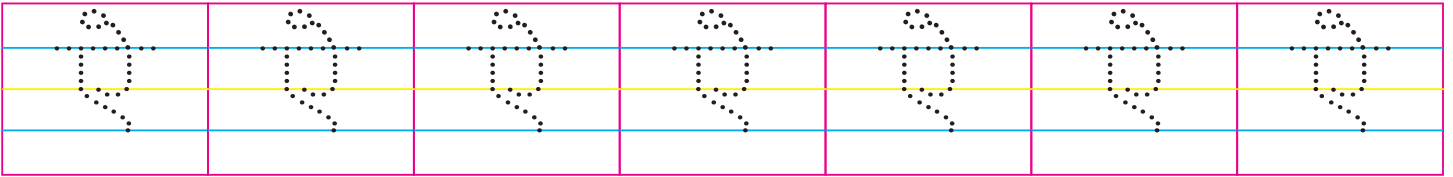
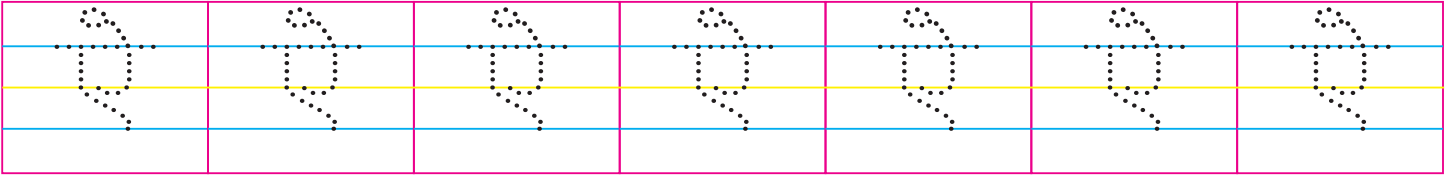
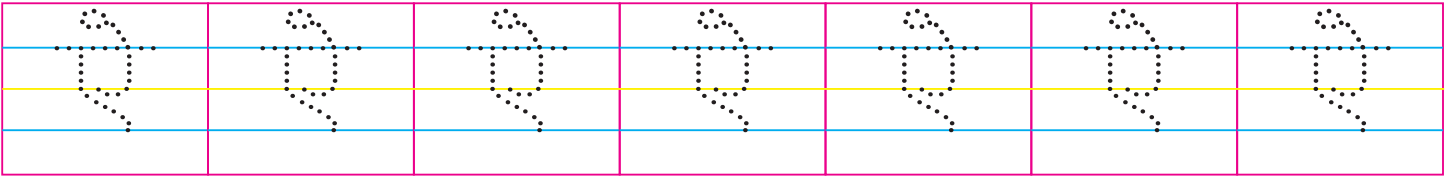
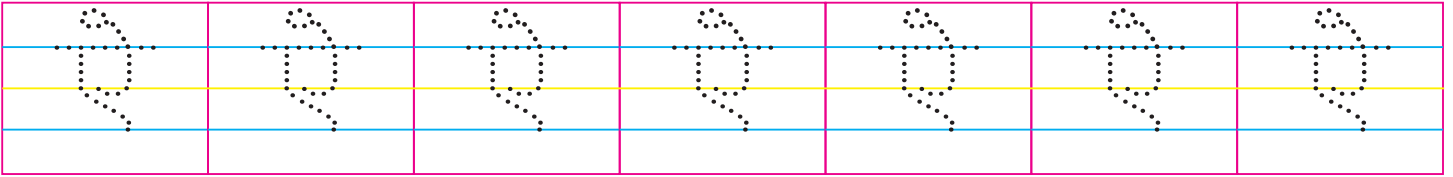
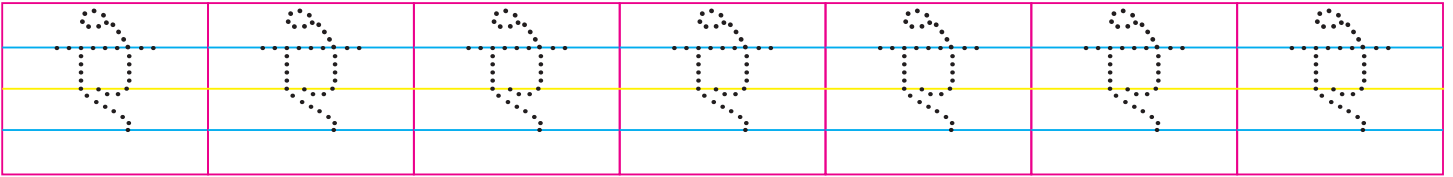
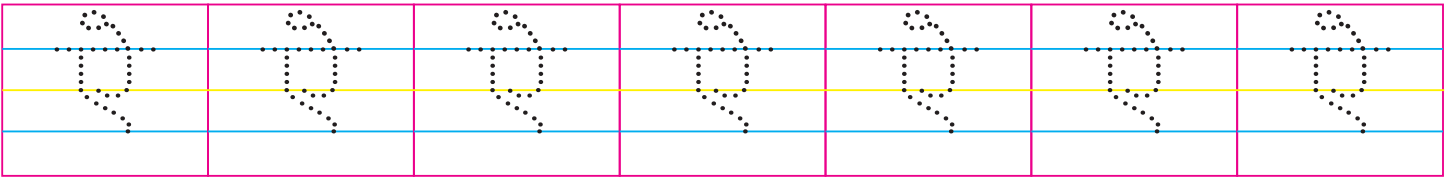
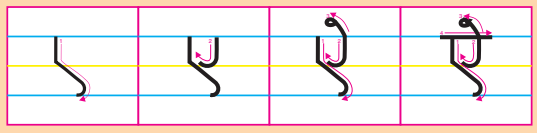

हस्ताक्षर :

दिनांक: ___/___/___

कक्षा कार्य / गृह कार्य

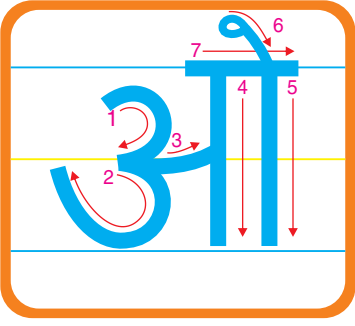

ओखली

चित्र देखकर रंग भरिए-

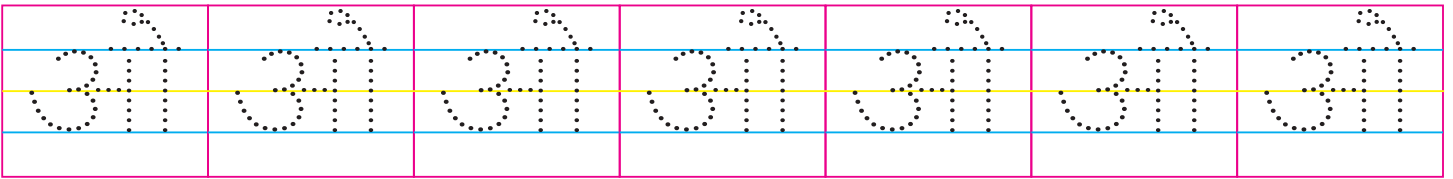
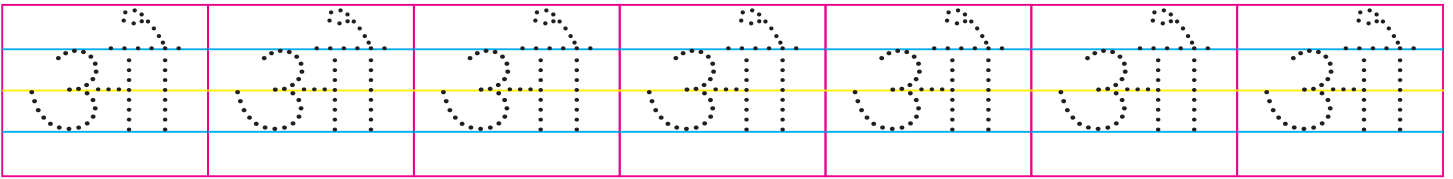
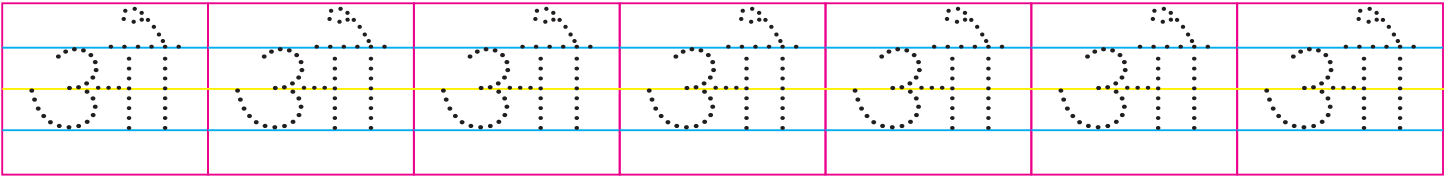
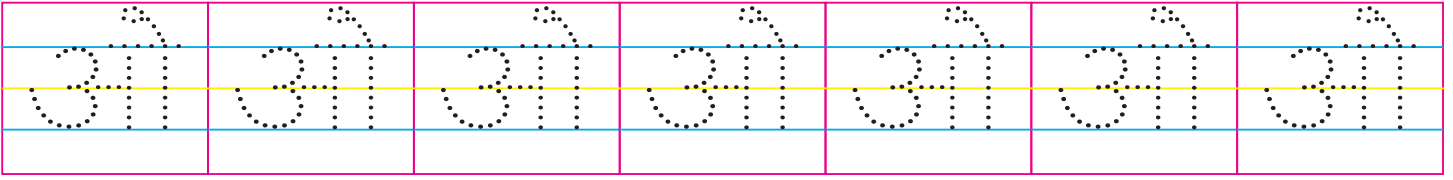
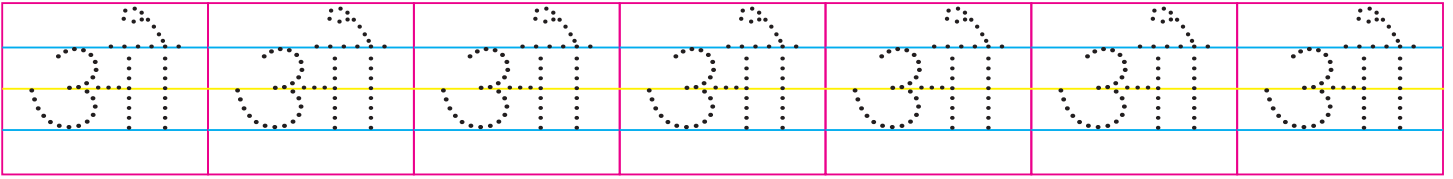
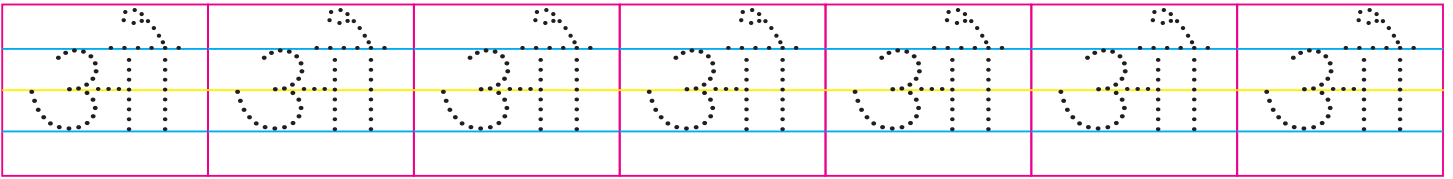
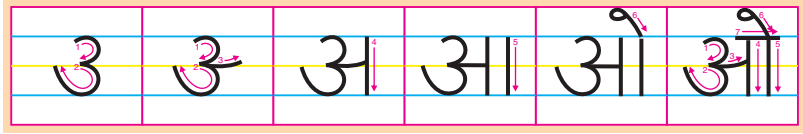

हस्ताक्षर :

दिनांक: ___/___/___

कक्षा कार्य / गृह कार्य

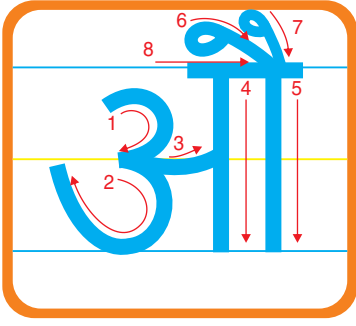

औरत

चित्र देखकर रंग भरिए-

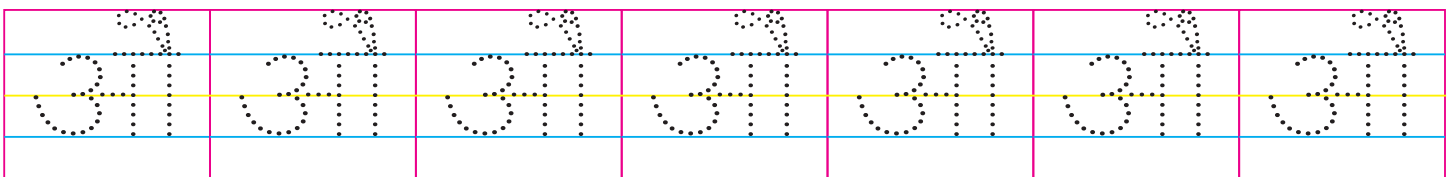
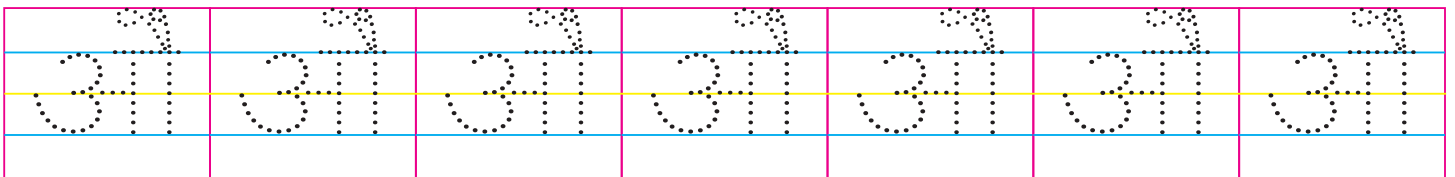
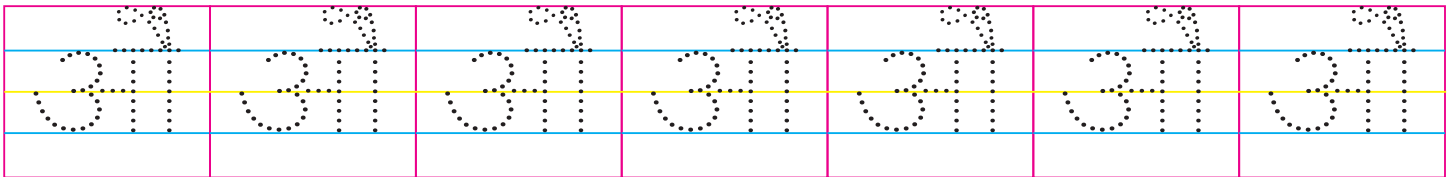
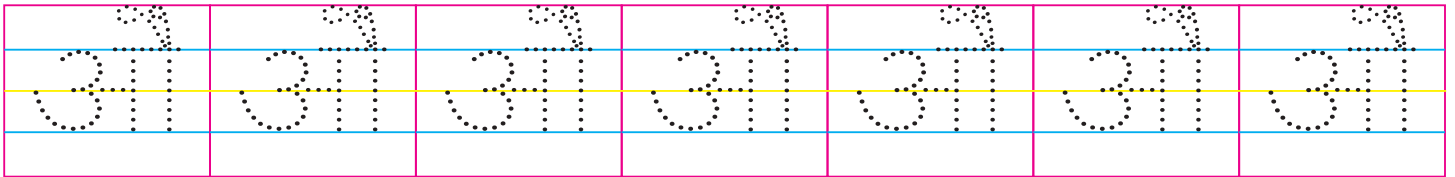
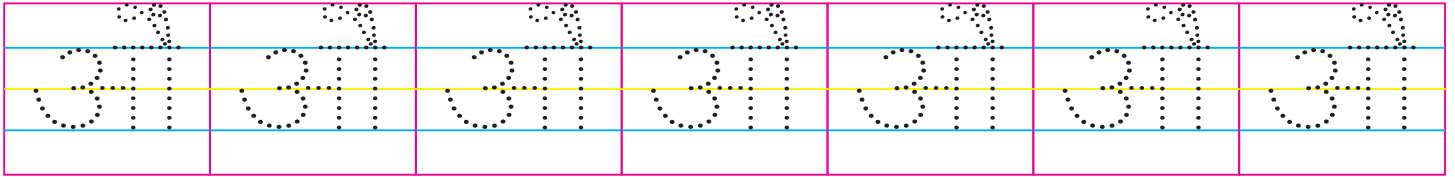
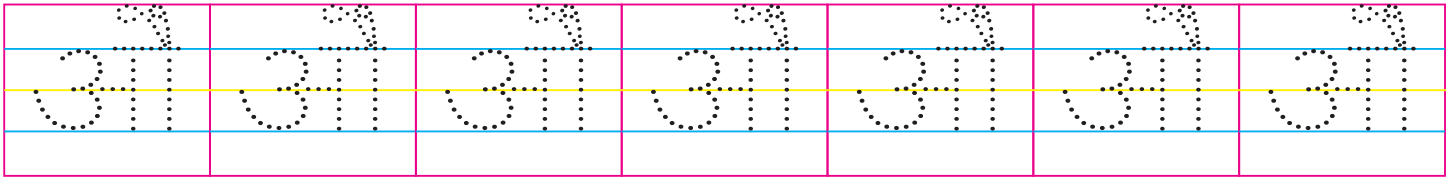
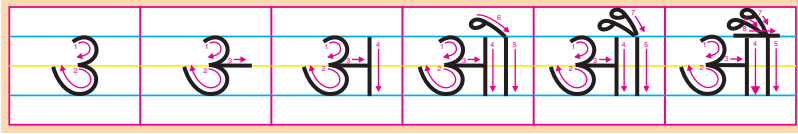

हस्ताक्षर :

दिनांक: ___/___/___

कक्षा कार्य / गृह कार्य

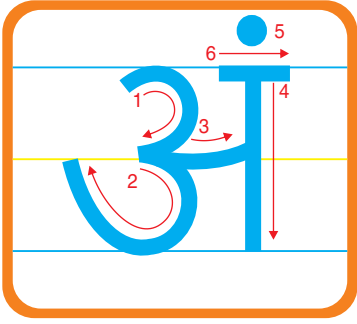

अंगूर

चित्र देखकर रंग भरिए-

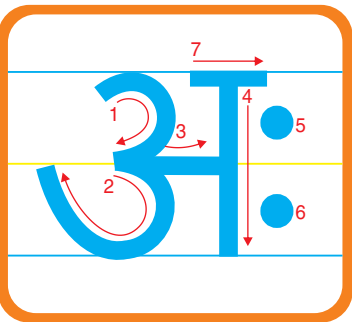
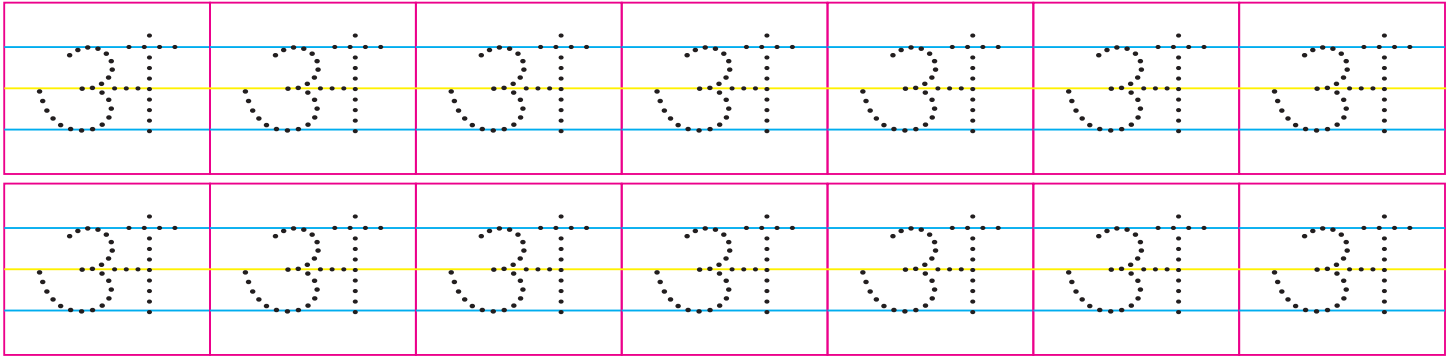
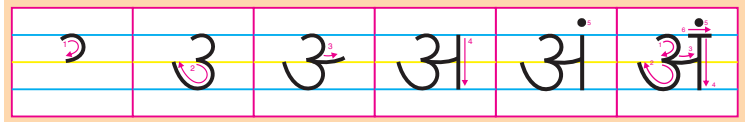
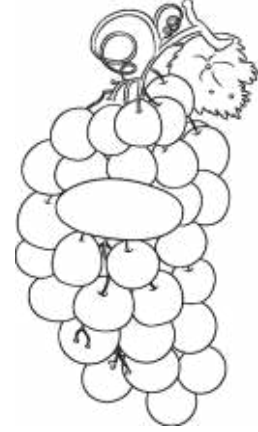

अः

चित्र देखकर रंग भरिए-

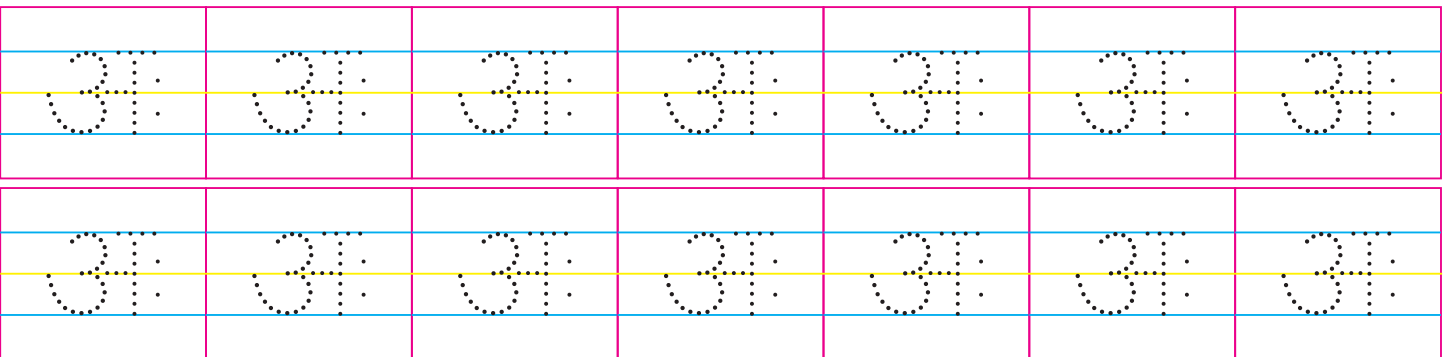
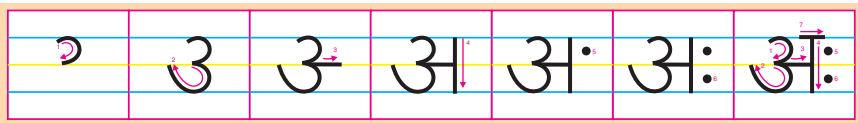

हस्ताक्षर :

अ से अः तक के अक्षरों को पुनः बोलकर लिखिये:

अ	आ	इ	ई				
उ	ऊ	ऋ	ए				
ऐ	ओ	औ	अं				
	अः						

देखिए और पढ़िए:

उ



ओ



अं



इ



ऊ



आ



दिनांक: ___/___/___

कक्षा कार्य / गृह कार्य

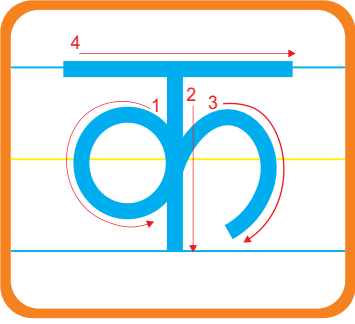

चित्र देखकर रंग भरिए-

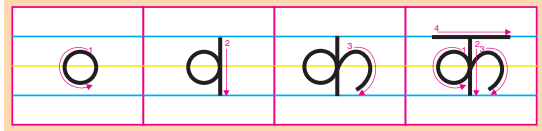
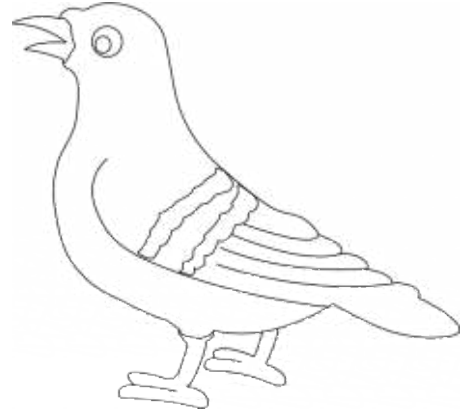

कबूतर

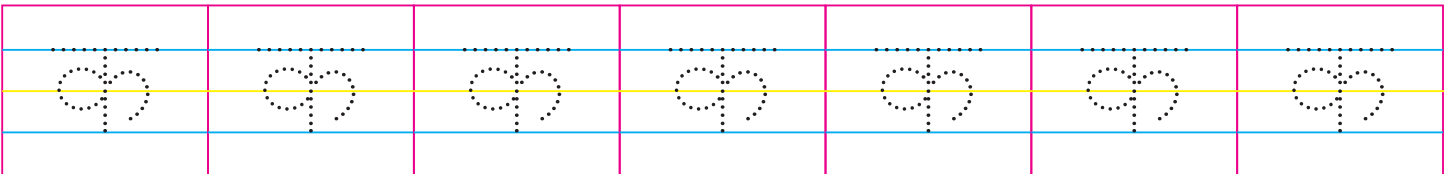
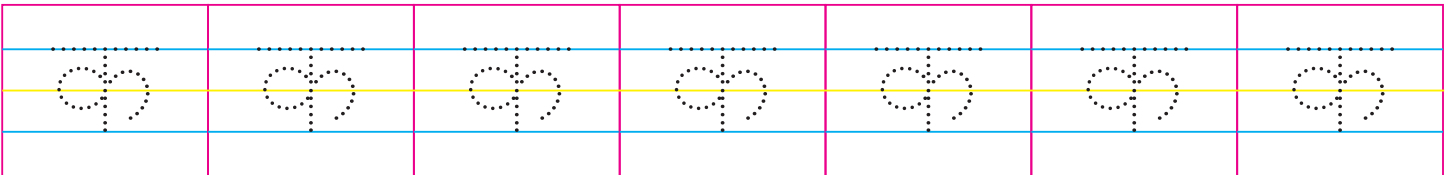
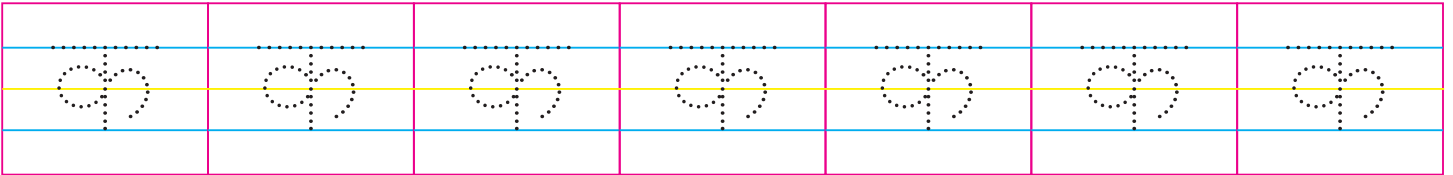
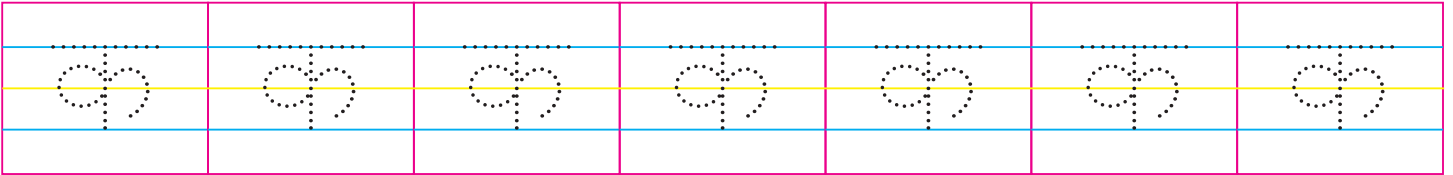
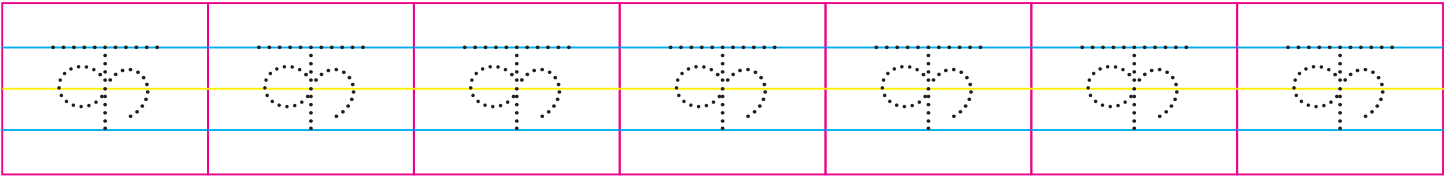
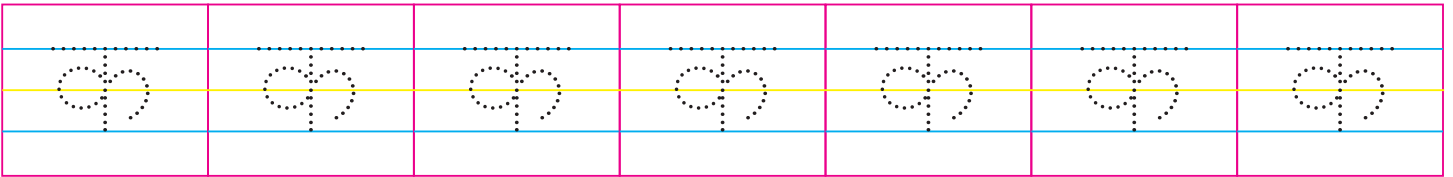

हस्ताक्षर :

दिनांक: ___/___/___

कक्षा कार्य / गृह कार्य

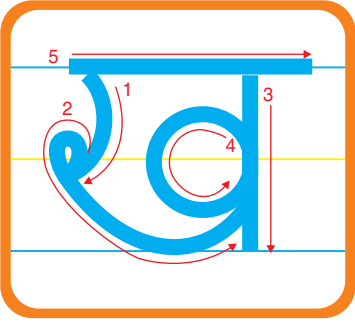

खरगोश

चित्र देखकर रंग भरिए-

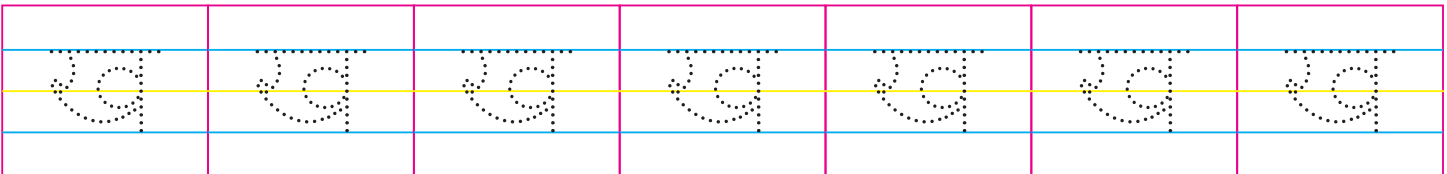
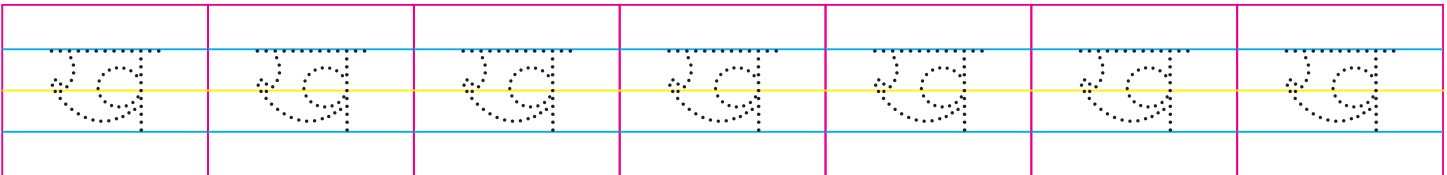
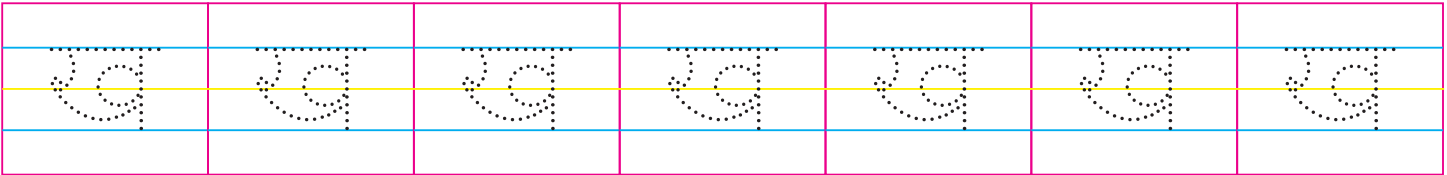
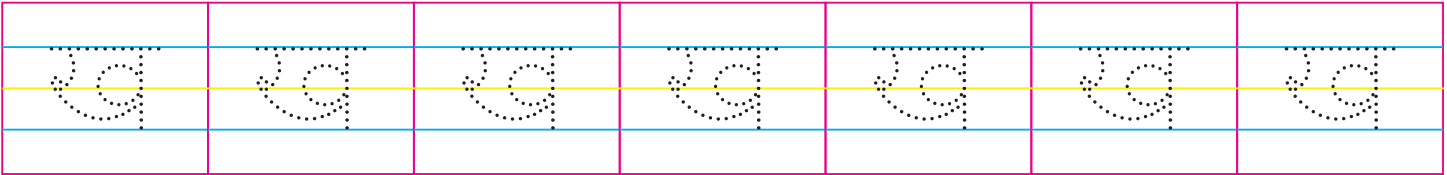
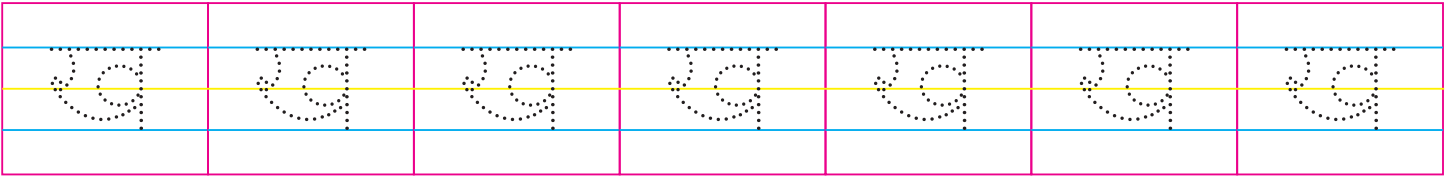
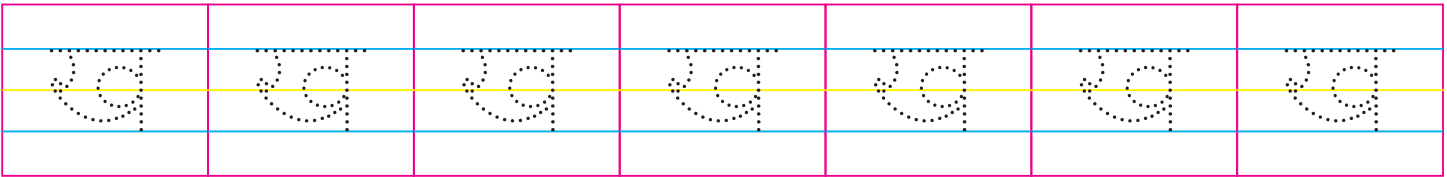
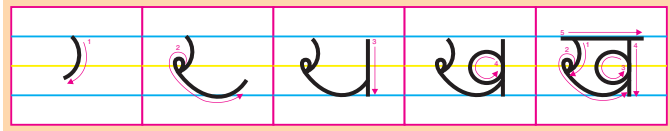
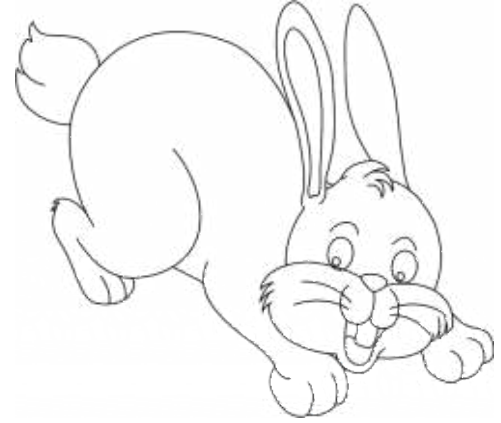

हस्ताक्षर :

दिनांक: ___/___/___

कक्षा कार्य / गृह कार्य

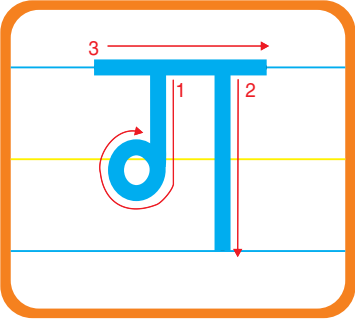

चित्र देखकर रंग भरिए-

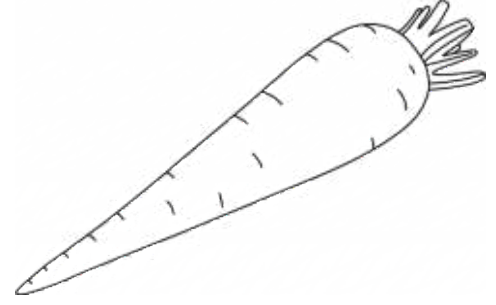

गाजर

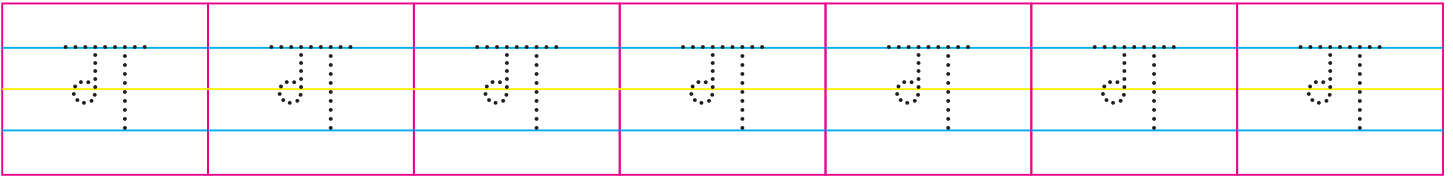
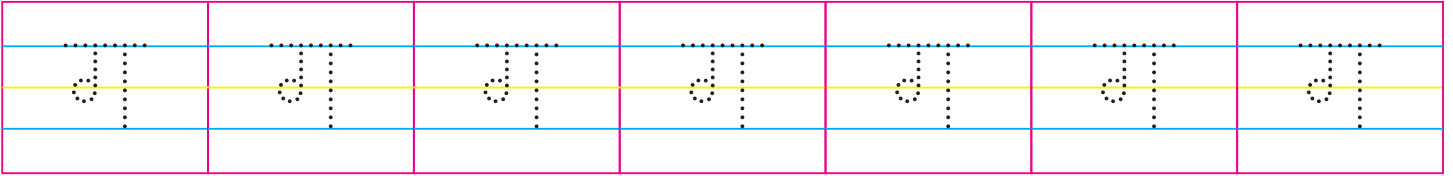
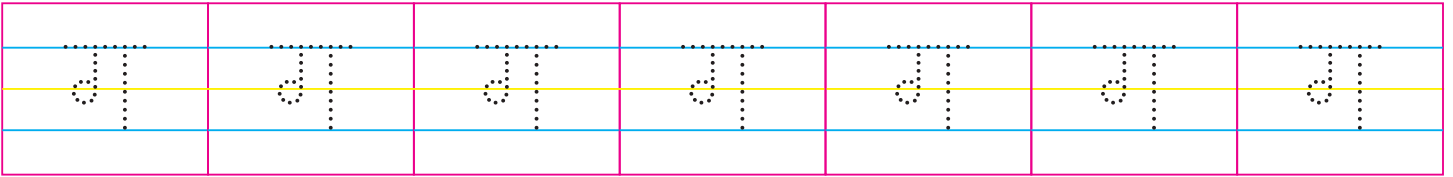
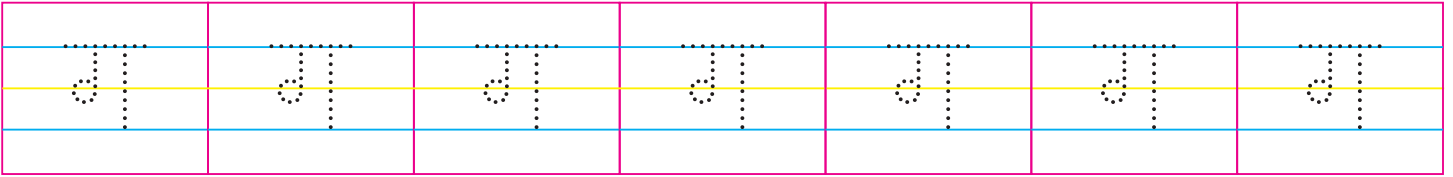
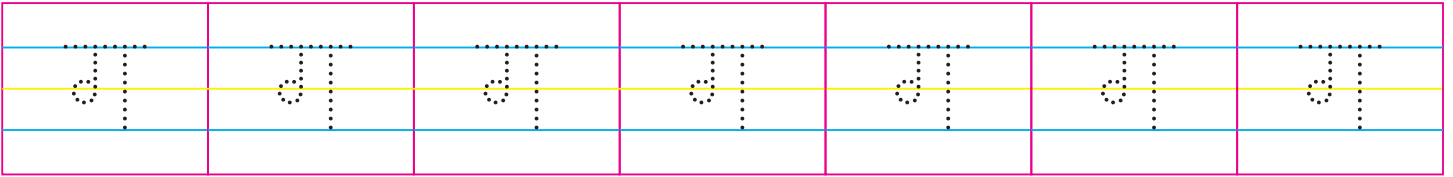
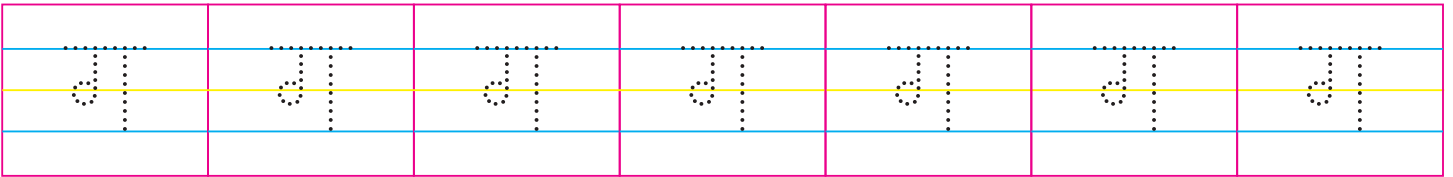
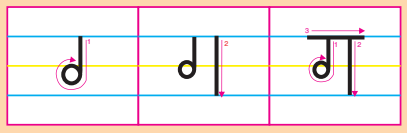

हस्ताक्षर :

दिनांक: ___/___/___

कक्षा कार्य / गृह कार्य

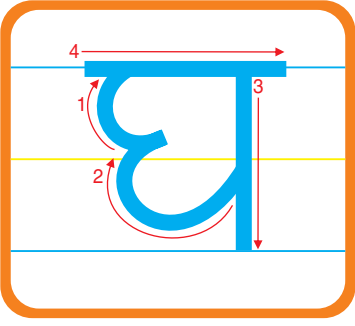

चित्र देखकर रंग भरिए-

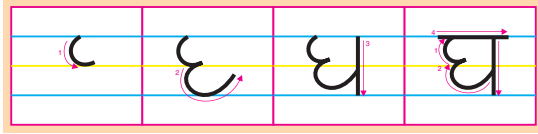

घर

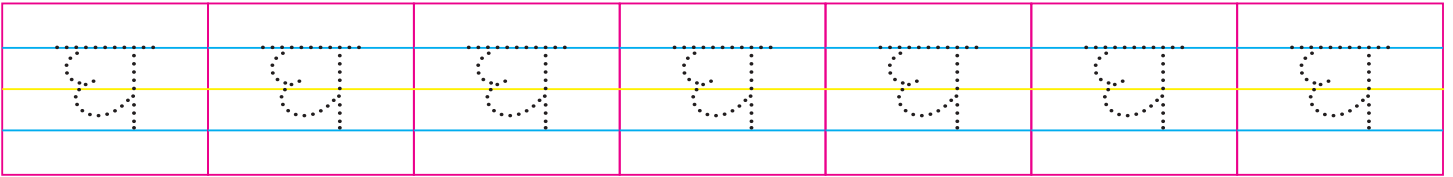
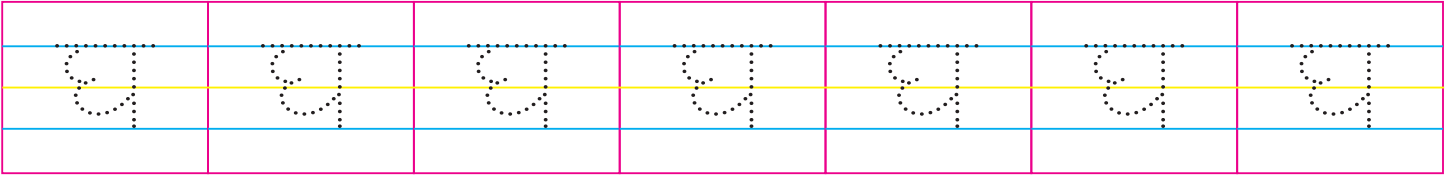
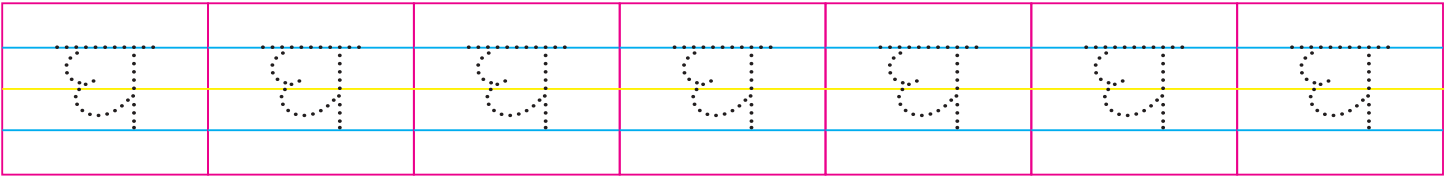
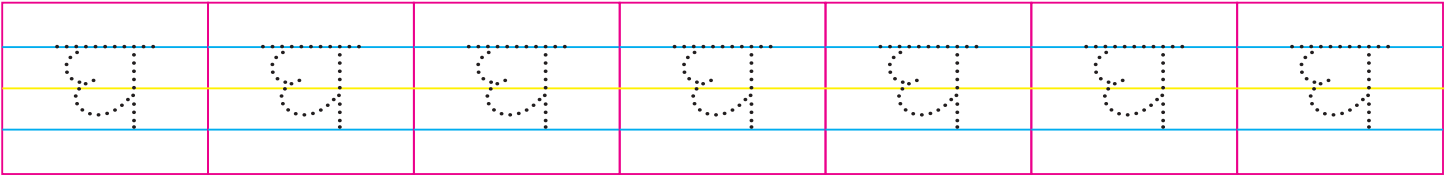
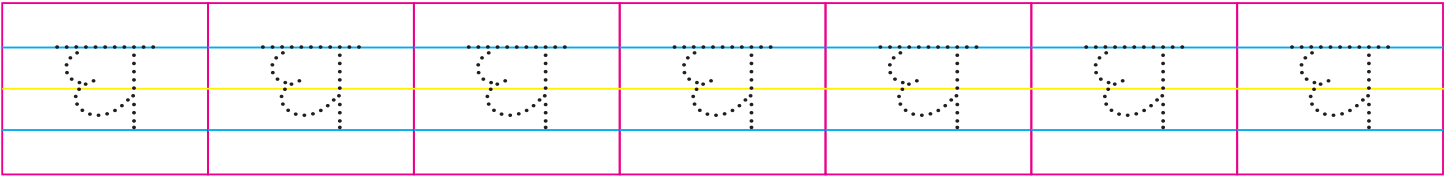
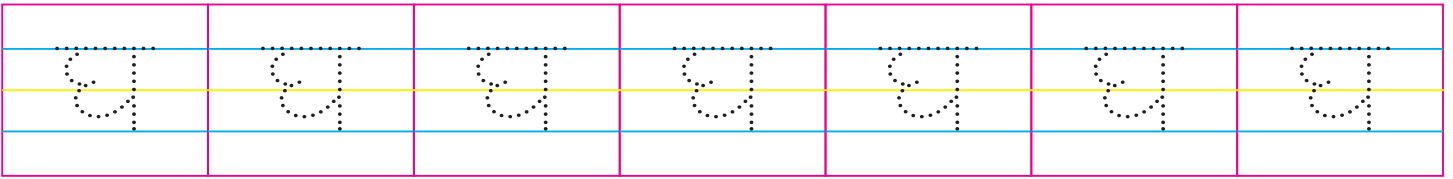

हस्ताक्षर :

दिनांक: ___/___/___

कक्षा कार्य / गृह कार्य

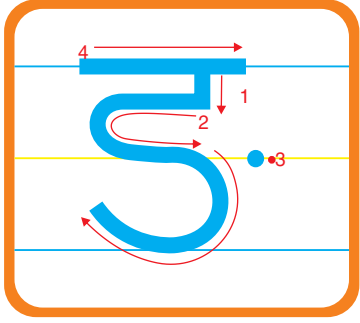

चित्र देखकर रंग भरिए-

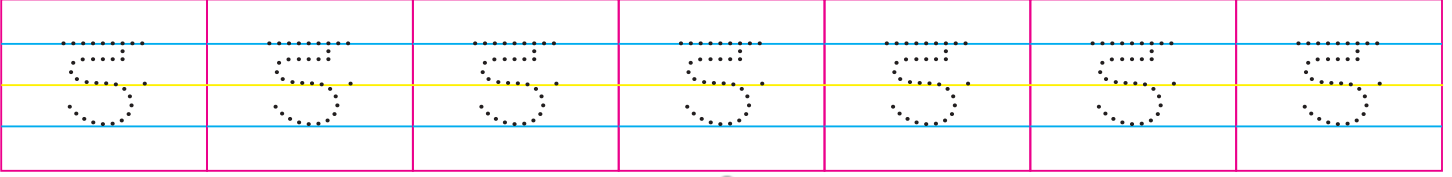
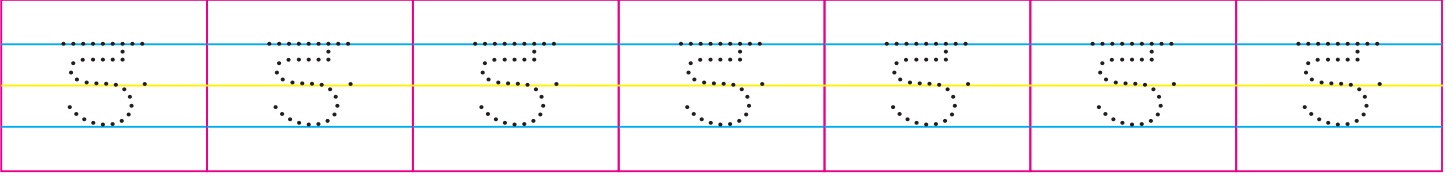
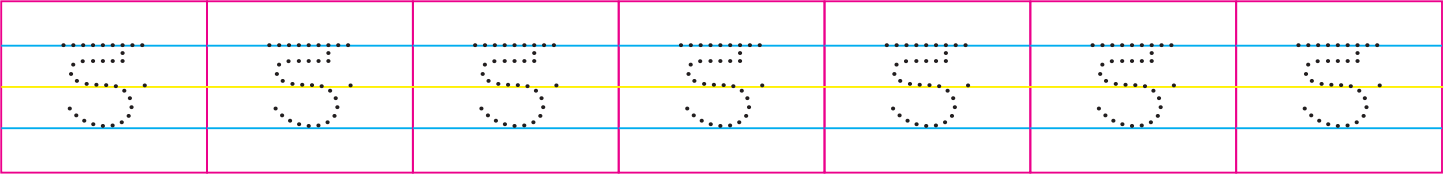
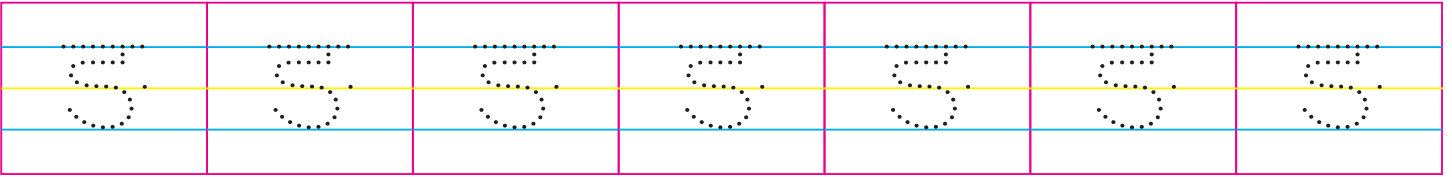
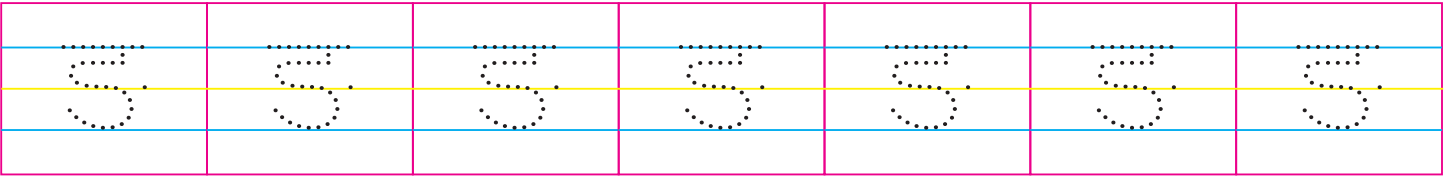
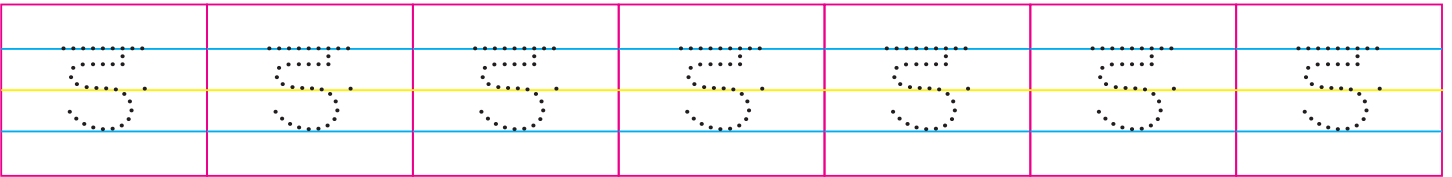
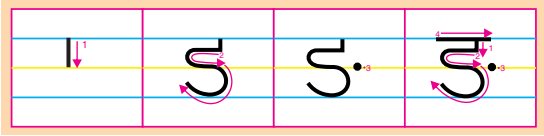
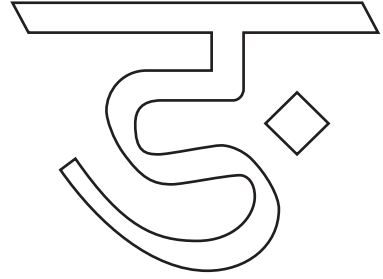

हस्ताक्षर :

दिनांक: ___/___/___

कक्षा कार्य / गृह कार्य

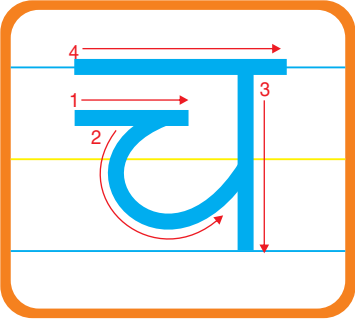

चित्र देखकर रंग भरिए-

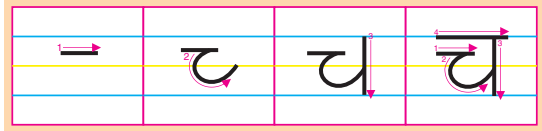
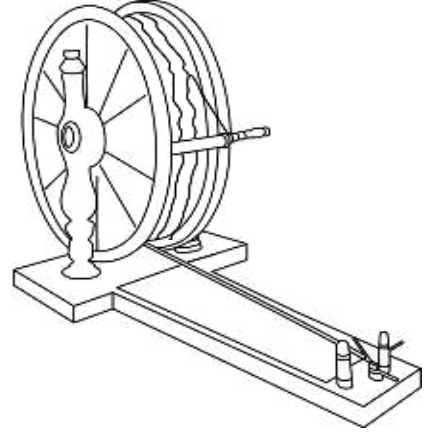

चरखा

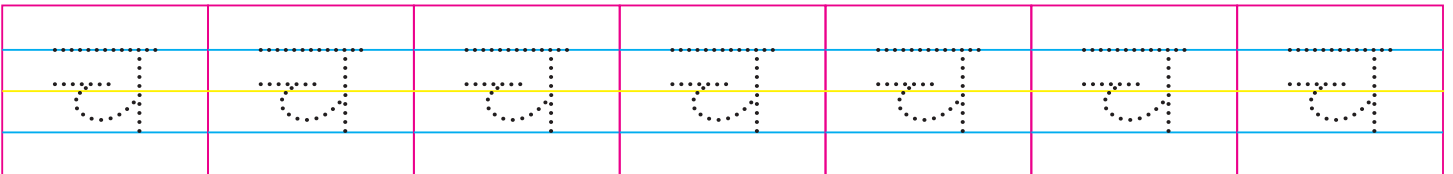
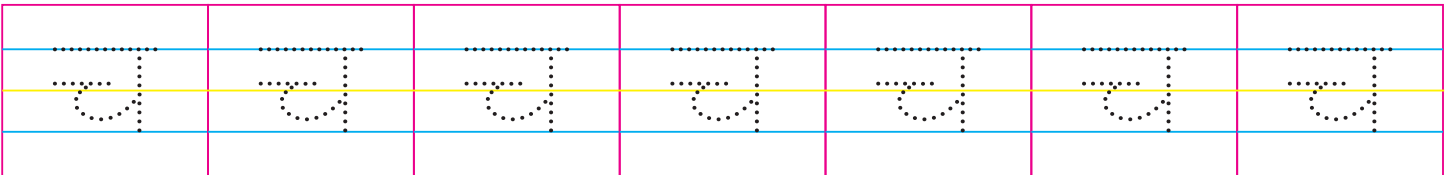
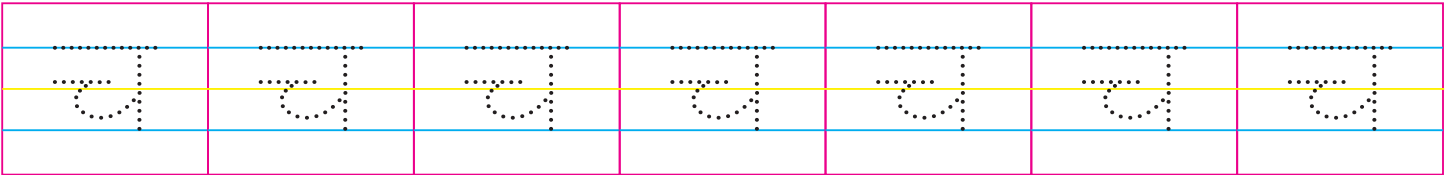
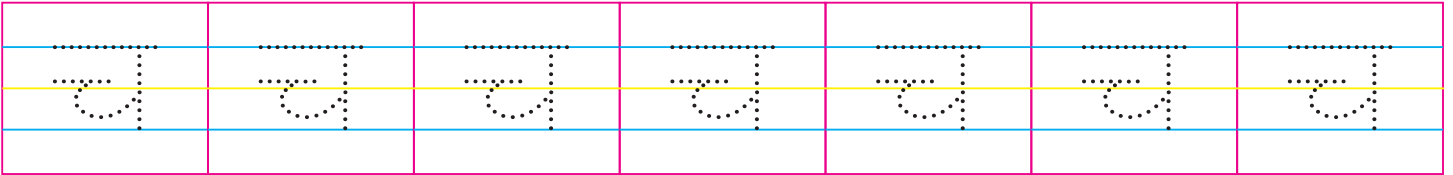
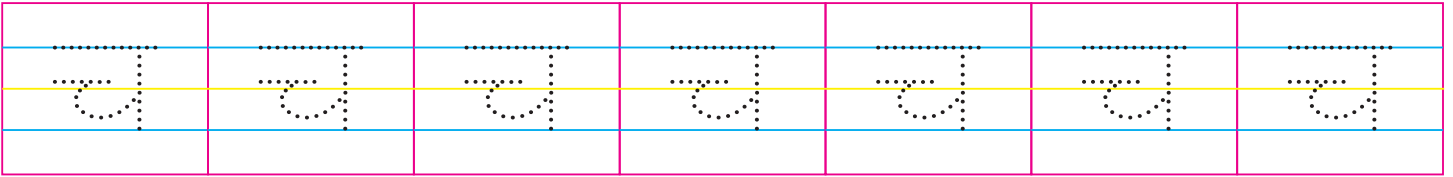
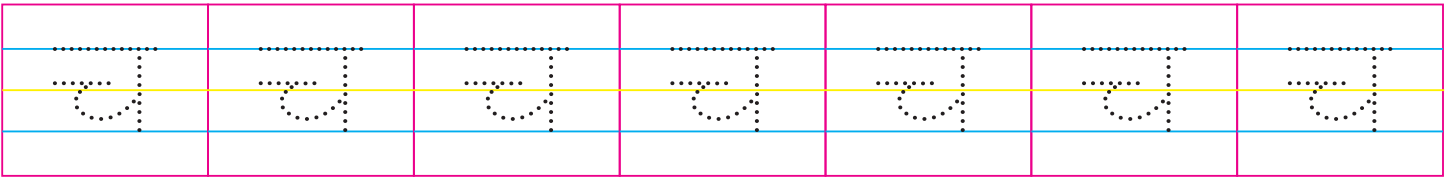

हस्ताक्षर :

दिनांक: ___/___/___

कक्षा कार्य / गृह कार्य

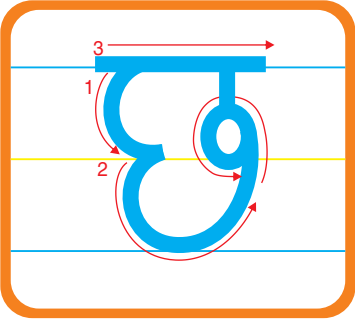

चित्र देखकर रंग भरिए-

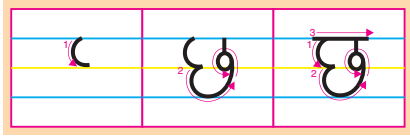

छतरी

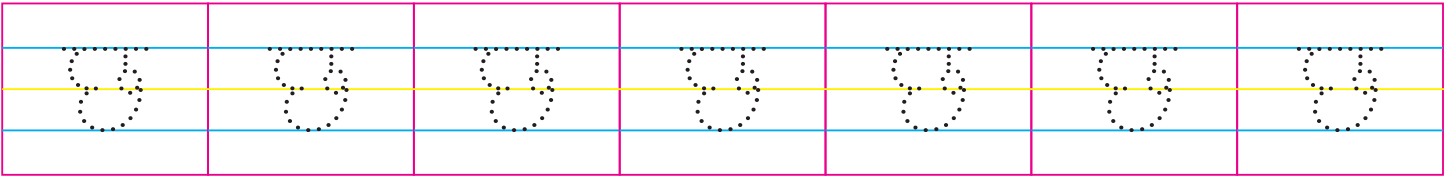
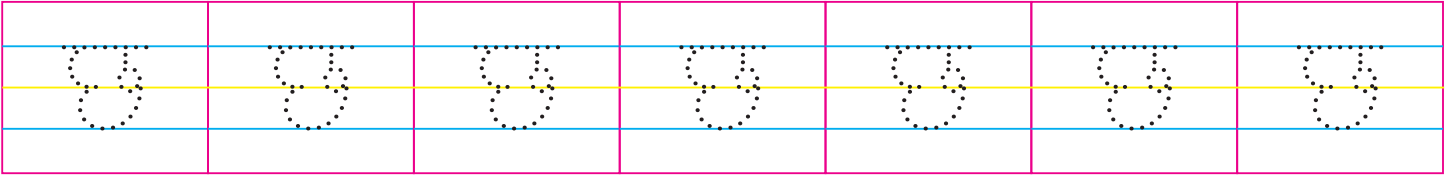
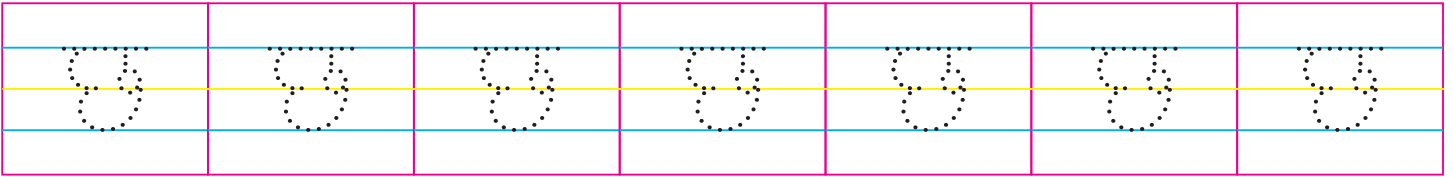
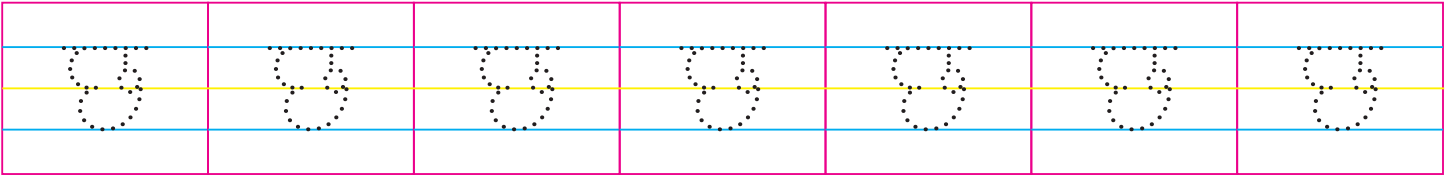
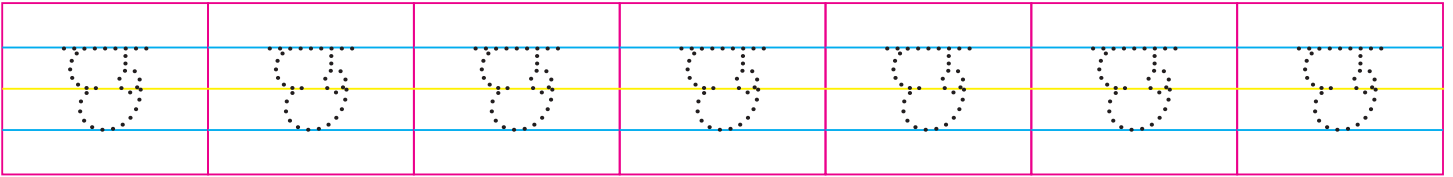
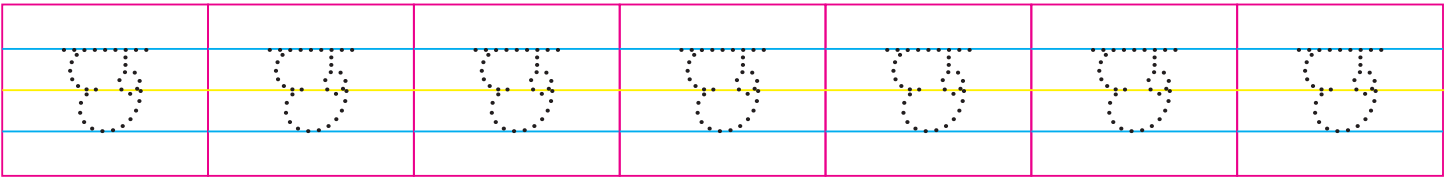

हस्ताक्षर :

दिनांक: ___/___/___

कक्षा कार्य / गृह कार्य

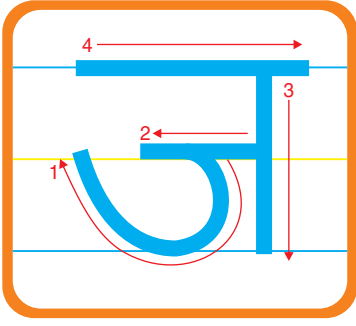

चित्र देखकर रंग भरिए-

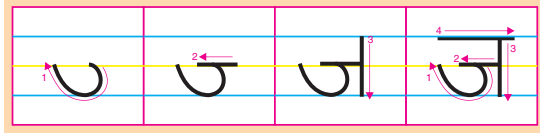
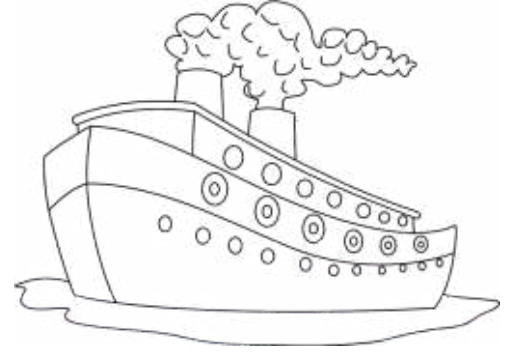

जहाज़

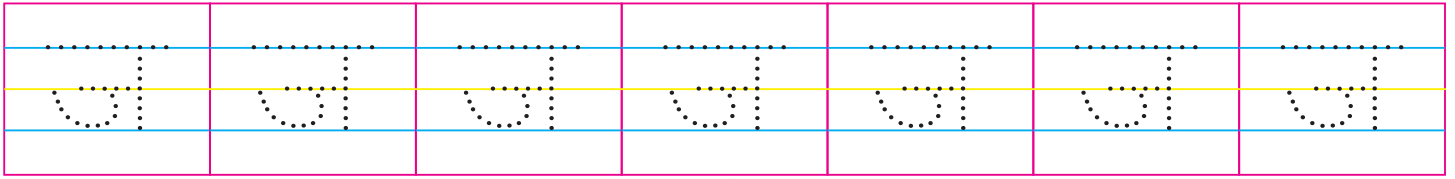
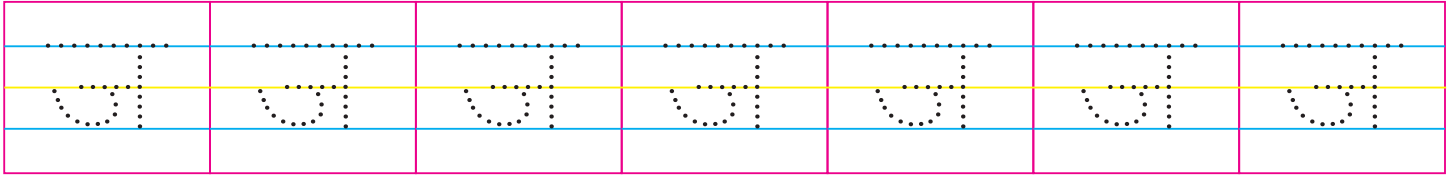
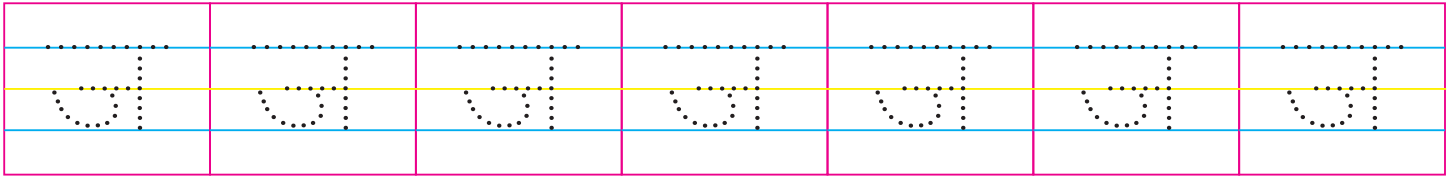
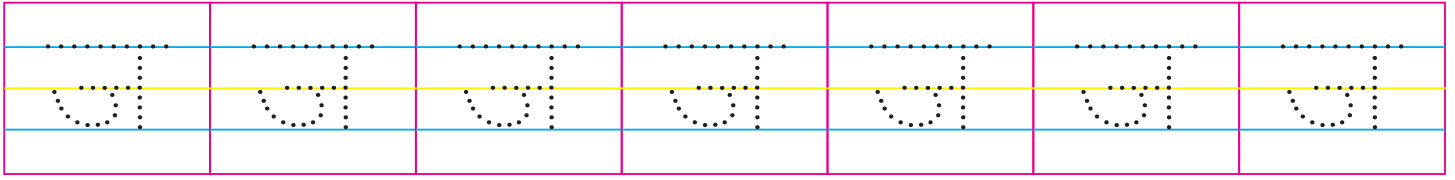
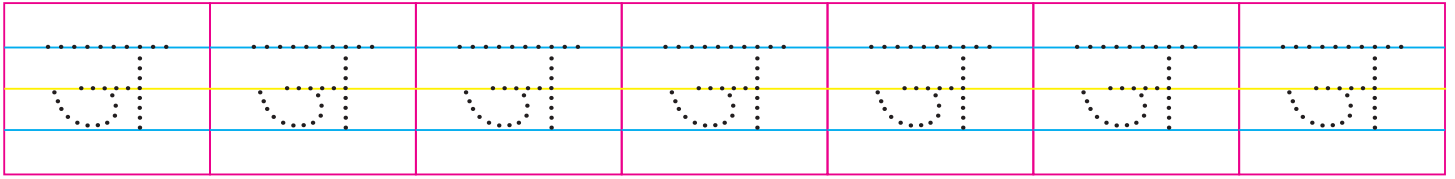
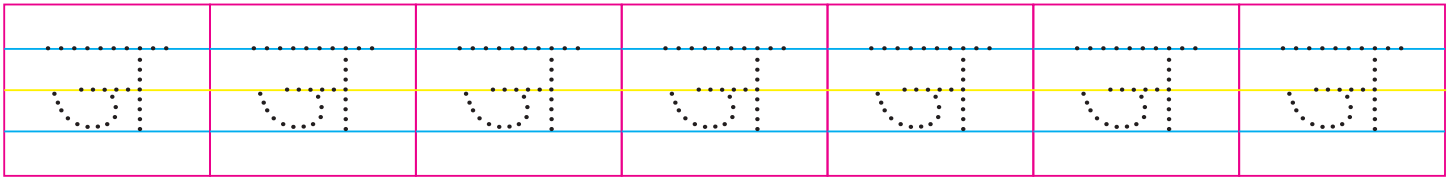

हस्ताक्षर :

दिनांक: ___/___/___

कक्षा कार्य / गृह कार्य

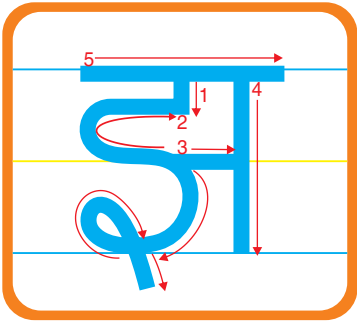

झंडा

चित्र देखकर रंग भरिए-

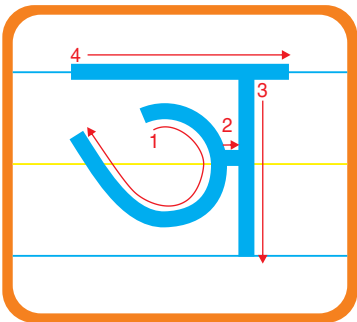
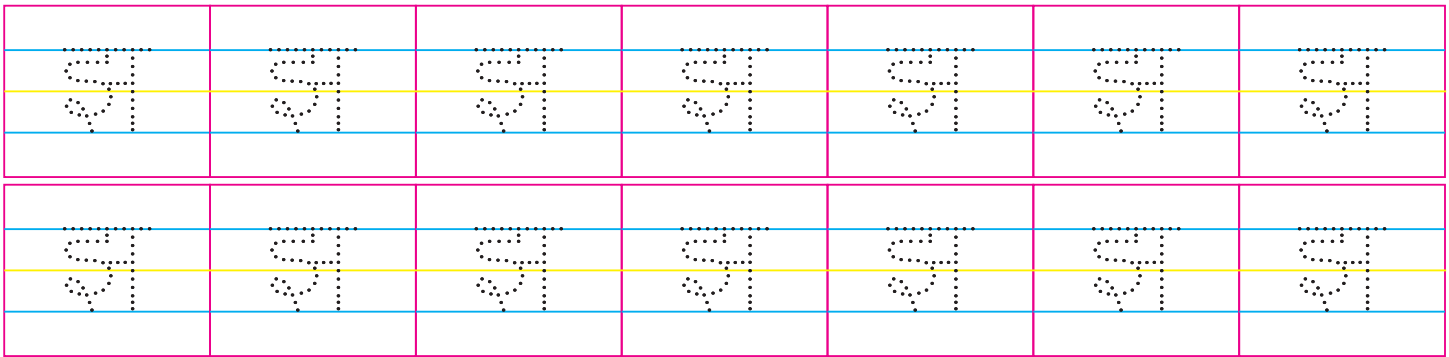
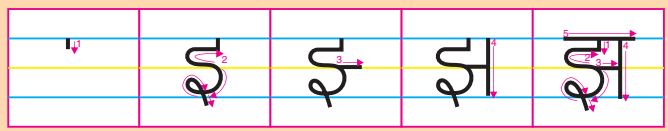
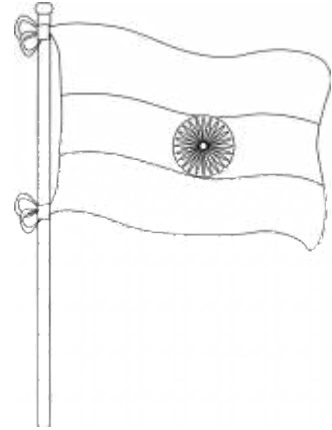

ज

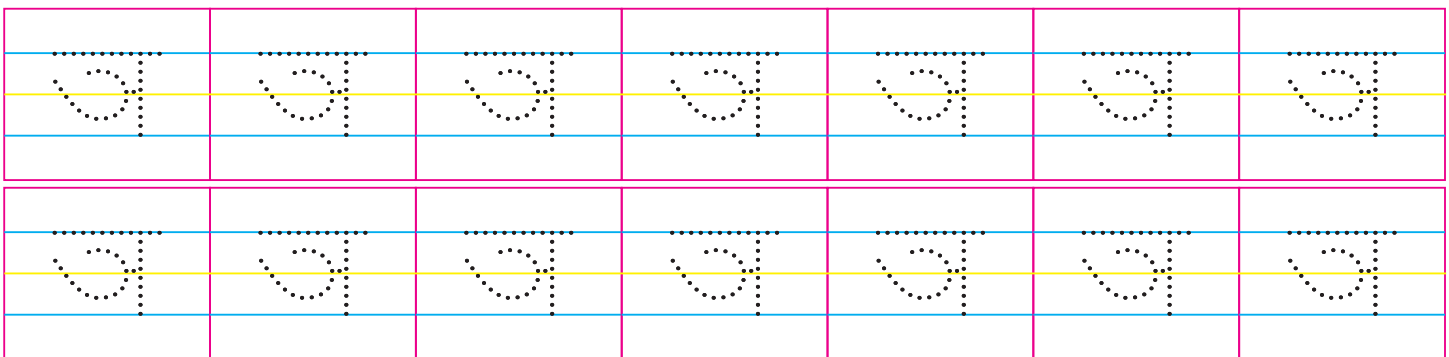
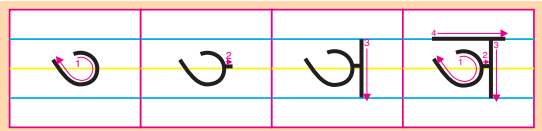
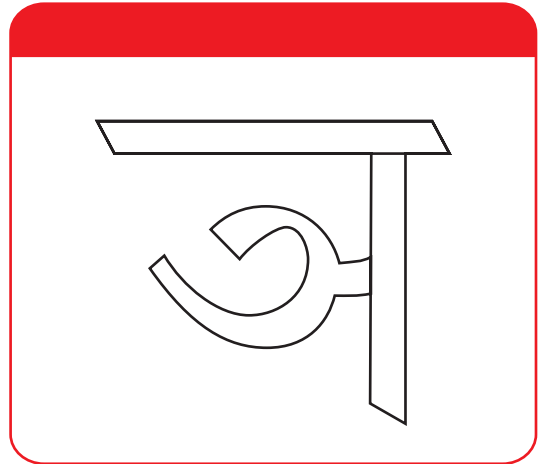

हस्ताक्षर :

दिनांक: ___/___/___

कक्षा कार्य ○ / गृह कार्य ○

चित्र को देखकर उसके नाम के प्रथम अक्षर को लिखिये:



अ से अ: तक लिखें:

Blank writing practice area consisting of two rows of six boxes each, and one additional box on the left side, all with three horizontal lines for writing.

क से अ तक लिखें:

Blank writing practice area with pre-filled characters. The first row contains 'क' in the first box and 'ग' in the third box. The second row contains 'छ' in the second box and 'झ' in the fourth box. All other boxes are empty, each with three horizontal lines for writing.

हस्ताक्षर :

दिनांक: ___/___/___

कक्षा कार्य / गृह कार्य

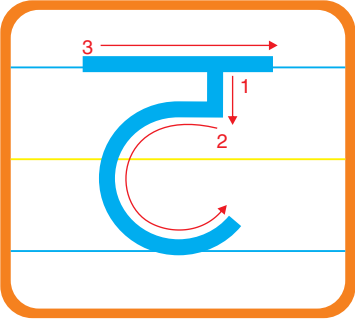

चित्र देखकर रंग भरिए-

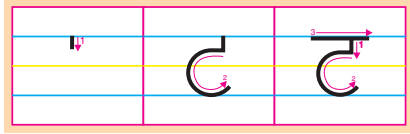
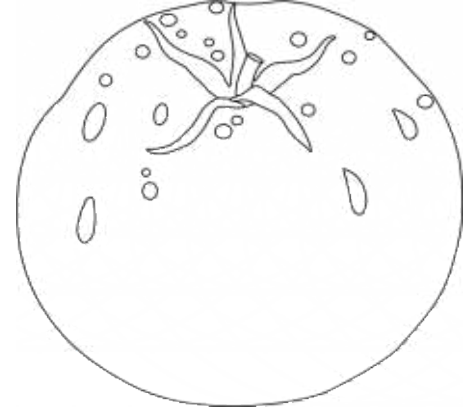

टमाटर

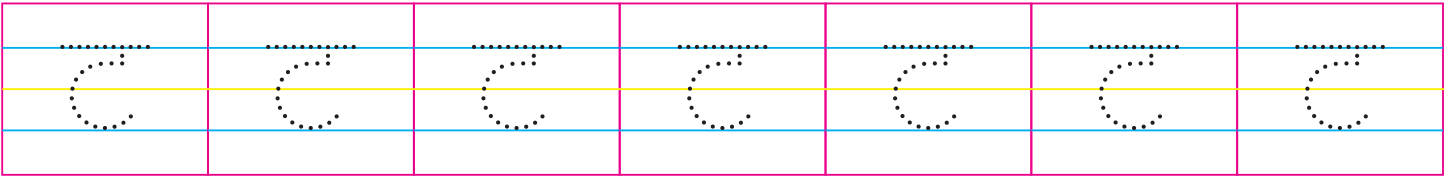
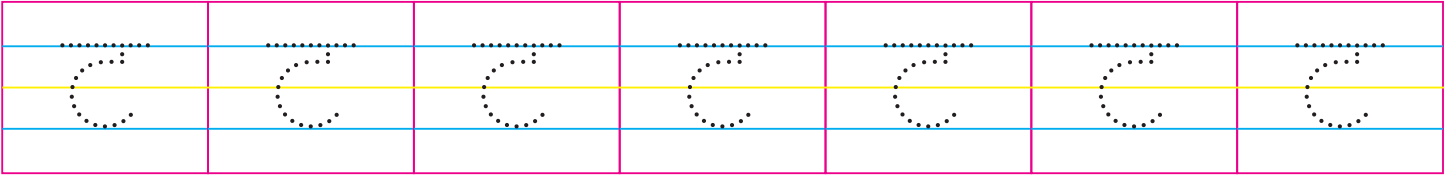
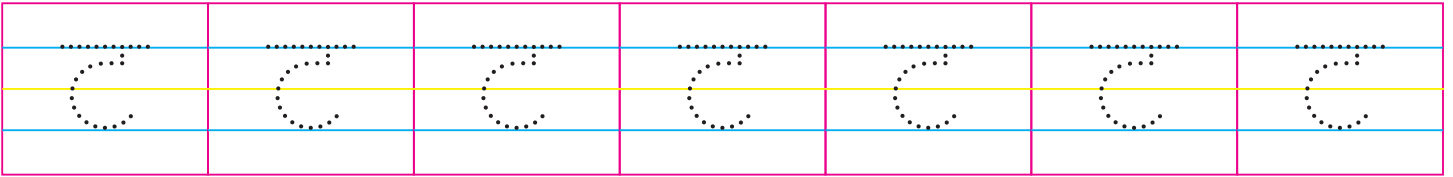
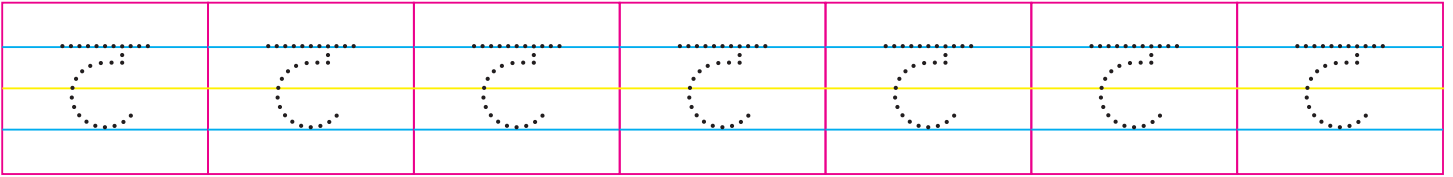
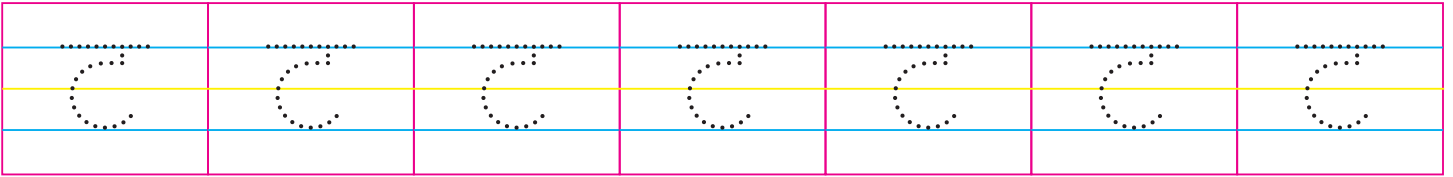
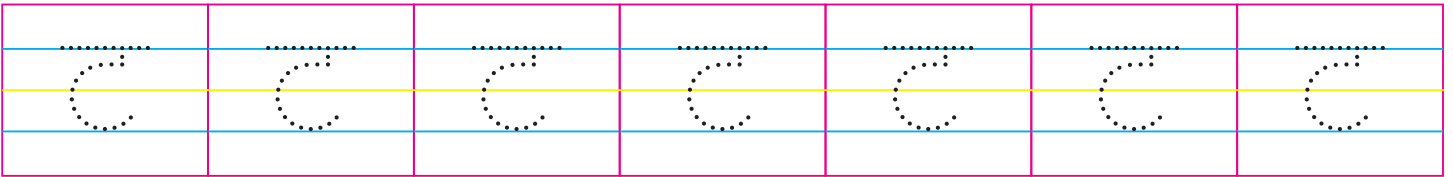

हस्ताक्षर :

दिनांक: ___/___/___

कक्षा कार्य / गृह कार्य

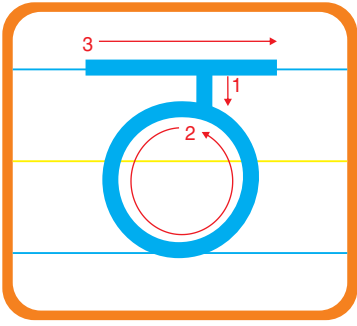

ठठेरा

चित्र देखकर रंग भरिए-

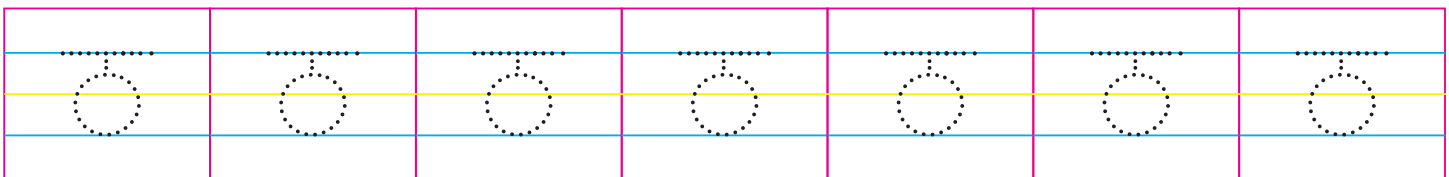
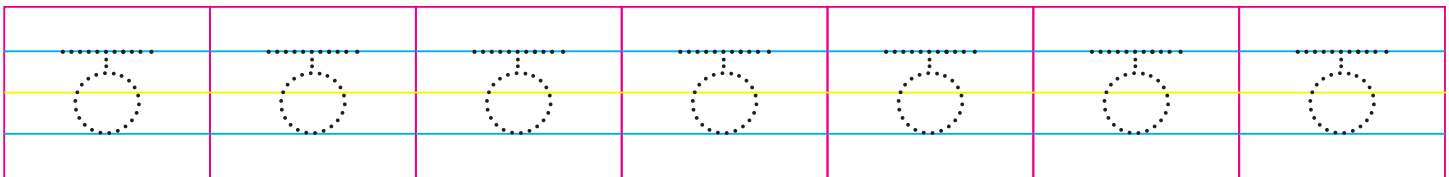
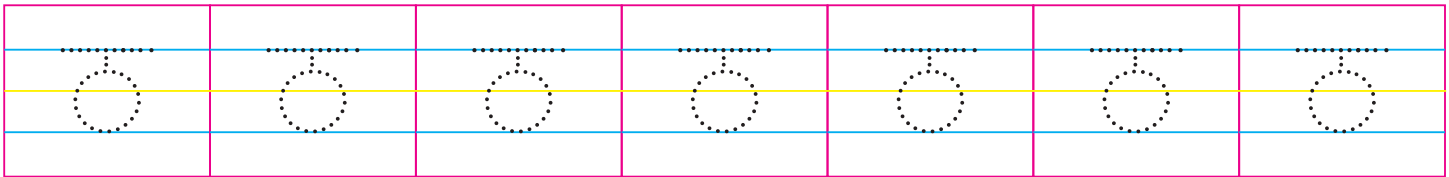
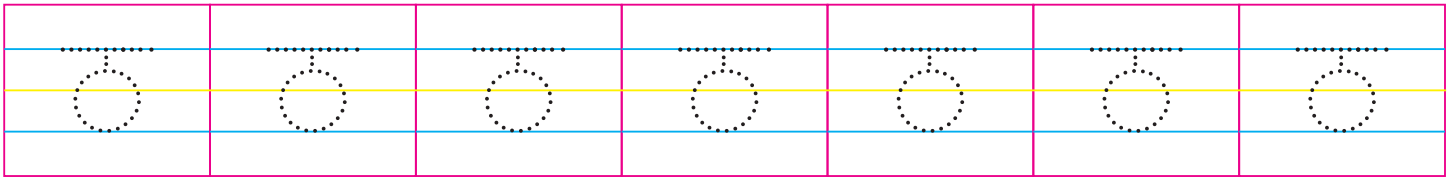
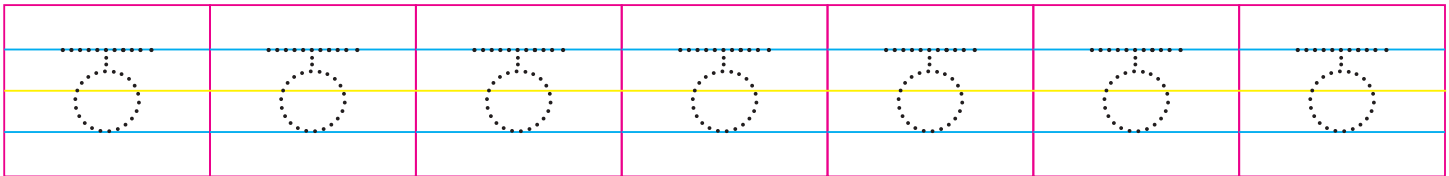
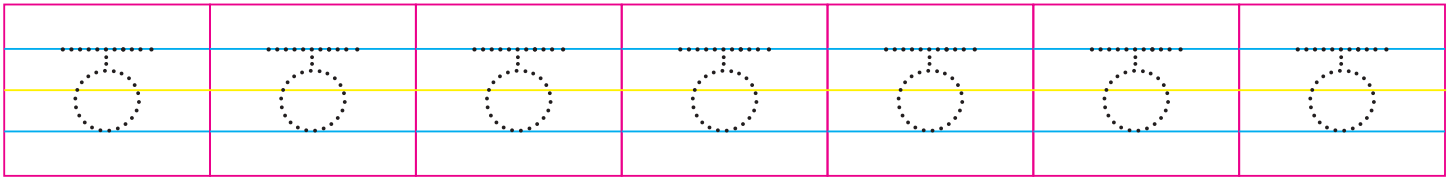
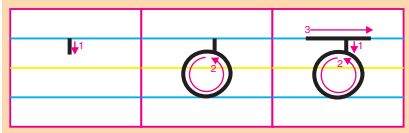

हस्ताक्षर :

दिनांक: ___/___/___

कक्षा कार्य / गृह कार्य

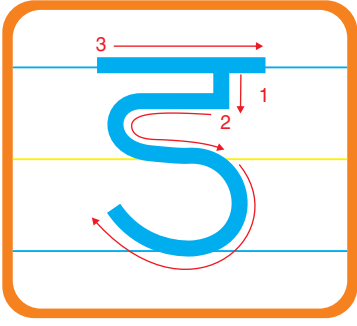

डमरू

चित्र देखकर रंग भरिए-

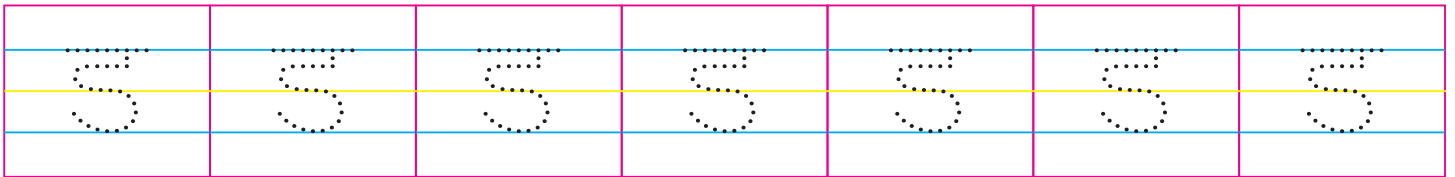
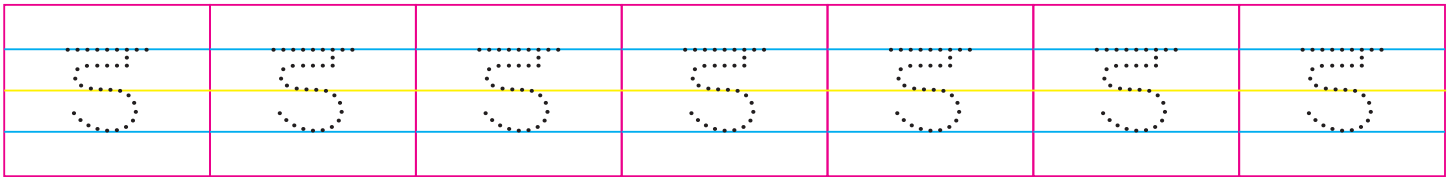
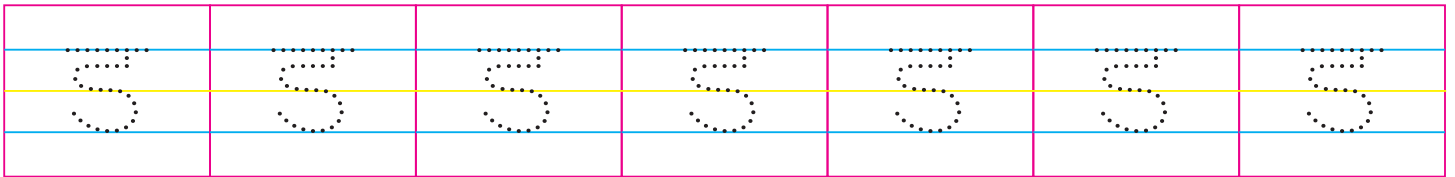
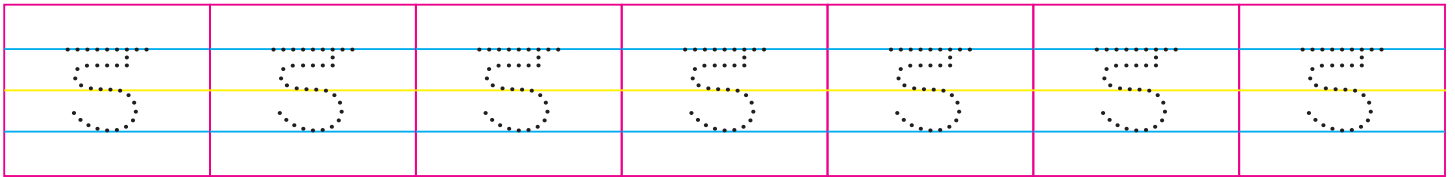
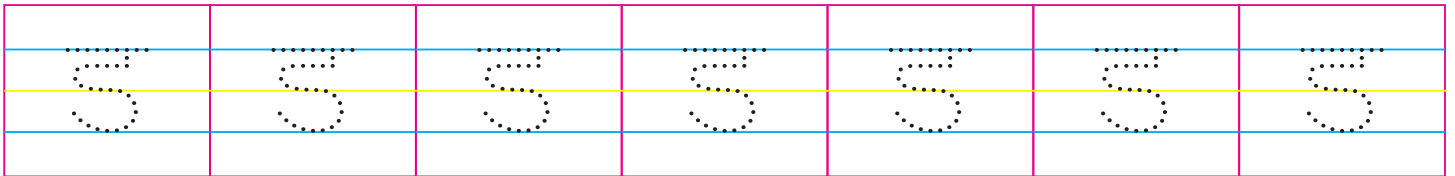
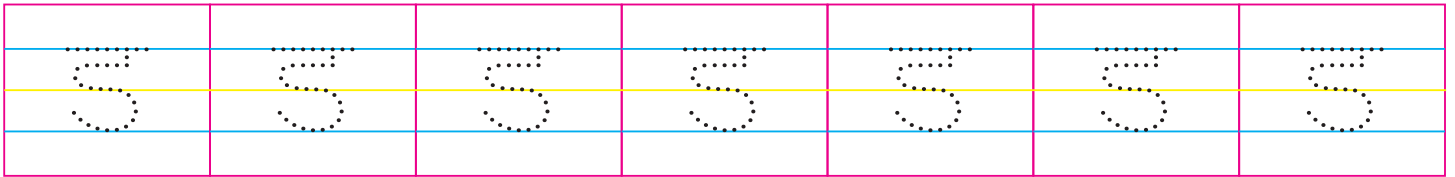
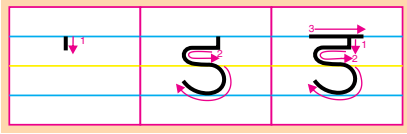
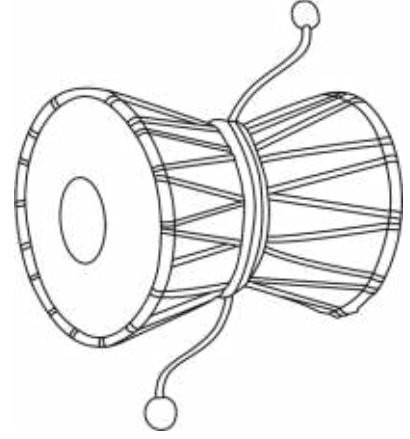

हस्ताक्षर :

दिनांक: ___/___/___

कक्षा कार्य / गृह कार्य

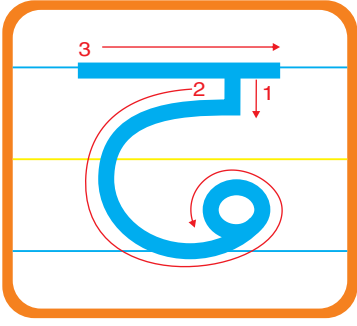

चित्र देखकर रंग भरिए-

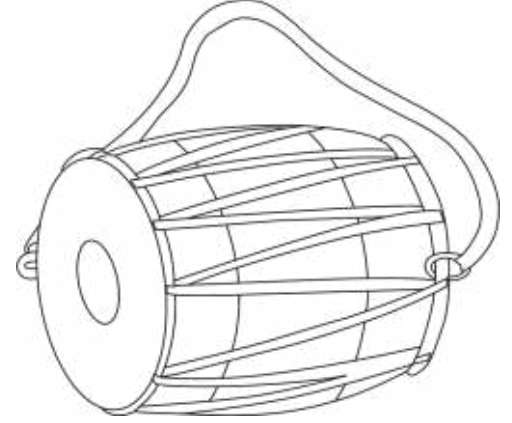

ढोल

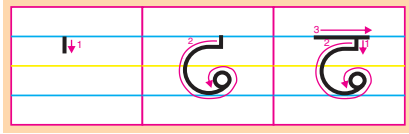

ढ	ढ	ढ	ढ	ढ	ढ	ढ
ढ	ढ	ढ	ढ	ढ	ढ	ढ
ढ	ढ	ढ	ढ	ढ	ढ	ढ
ढ	ढ	ढ	ढ	ढ	ढ	ढ
ढ	ढ	ढ	ढ	ढ	ढ	ढ
ढ	ढ	ढ	ढ	ढ	ढ	ढ

हस्ताक्षर :

दिनांक: ___/___/___

कक्षा कार्य / गृह कार्य

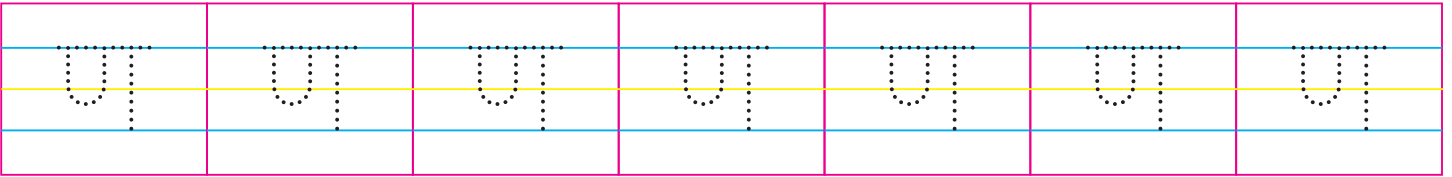
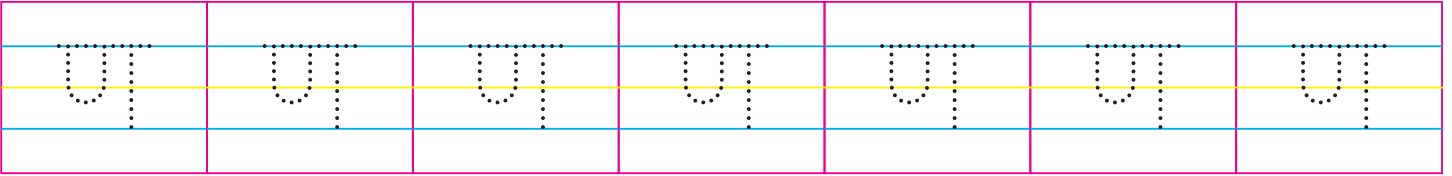
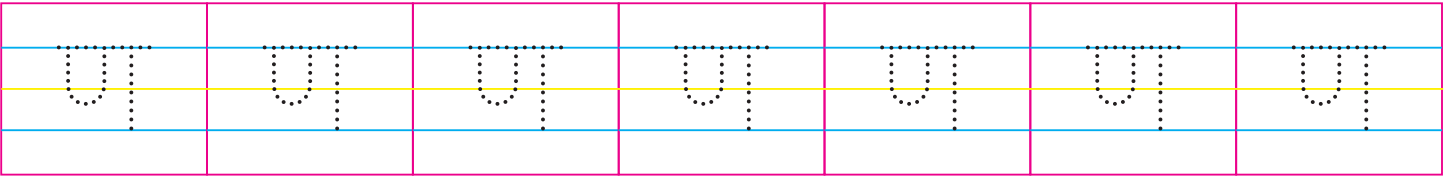
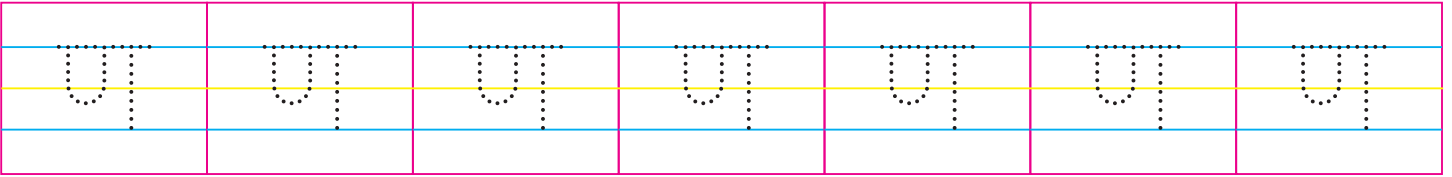
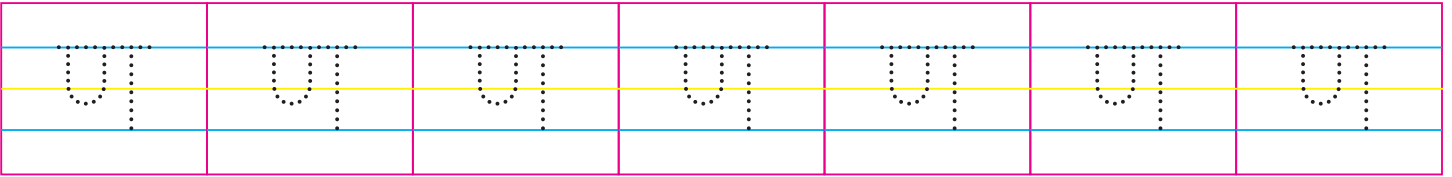
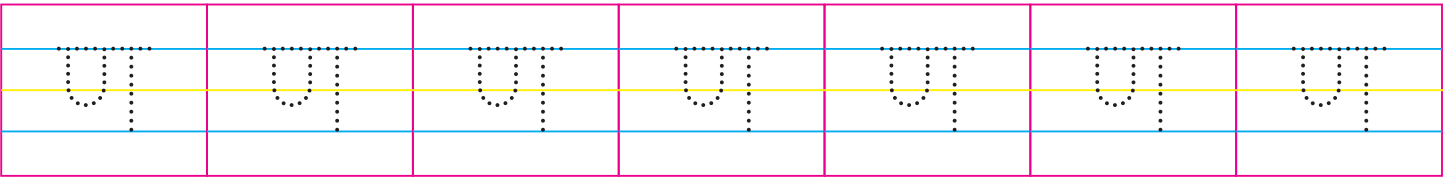
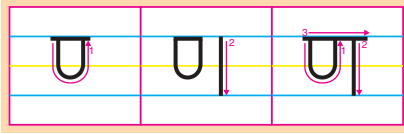
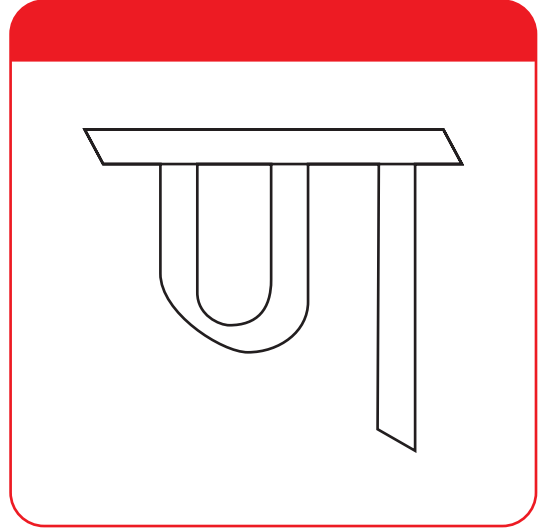
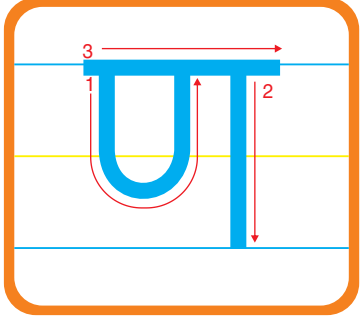

हस्ताक्षर :

दिनांक: ___/___/___

कक्षा कार्य / गृह कार्य

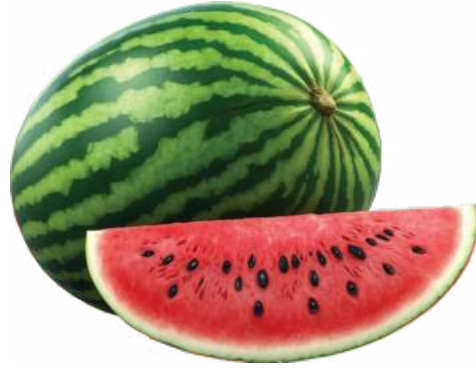
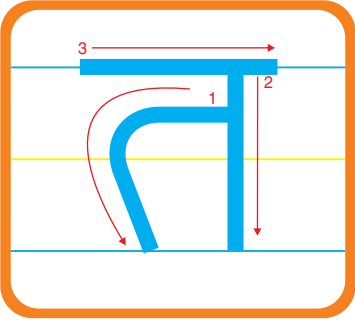

चित्र देखकर रंग भरिए-

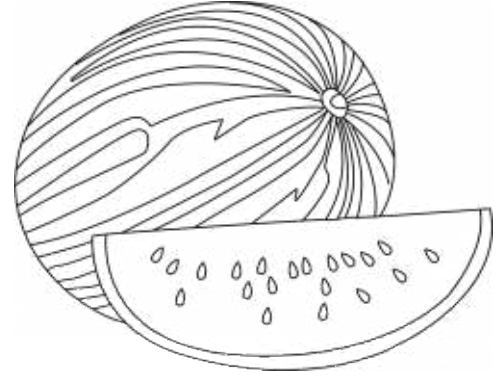

तरबूज़

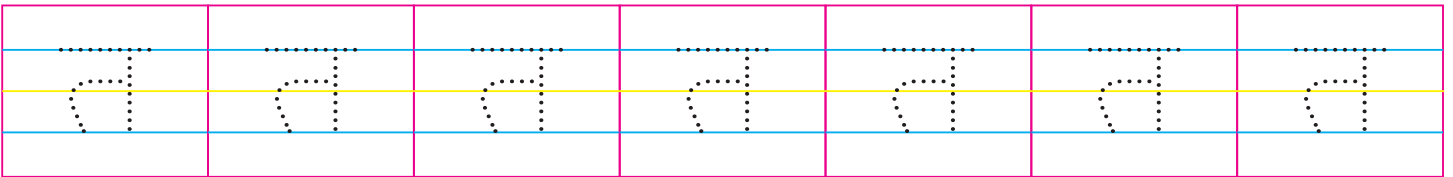
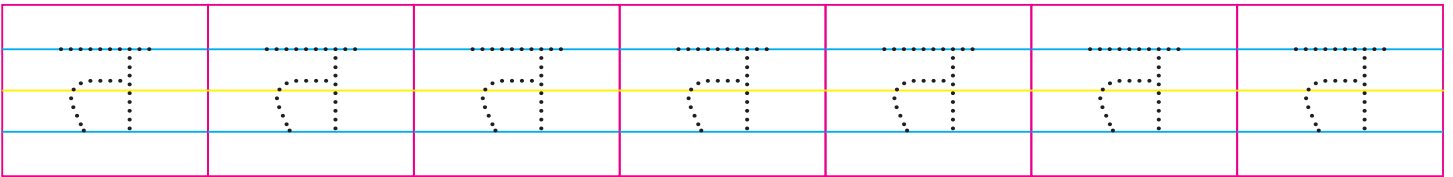
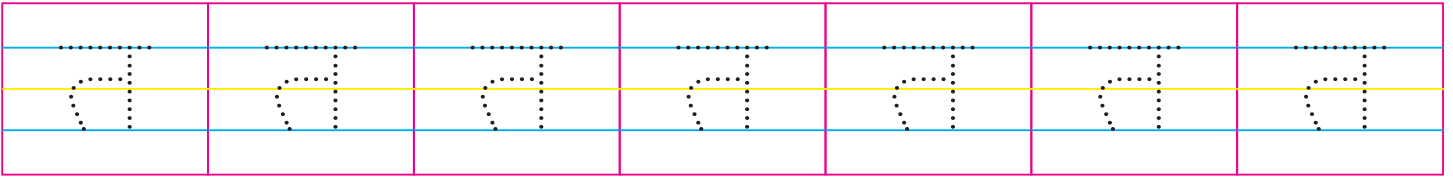
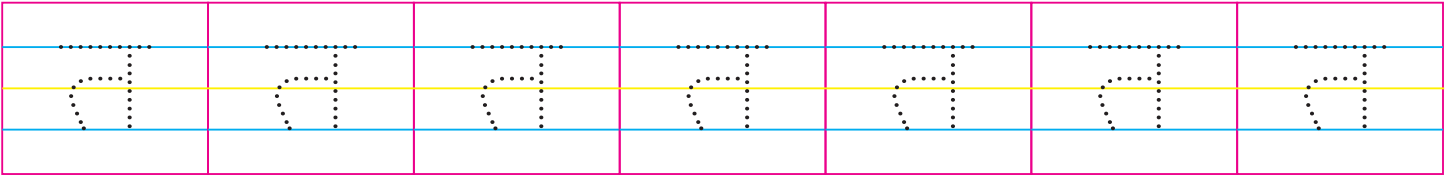
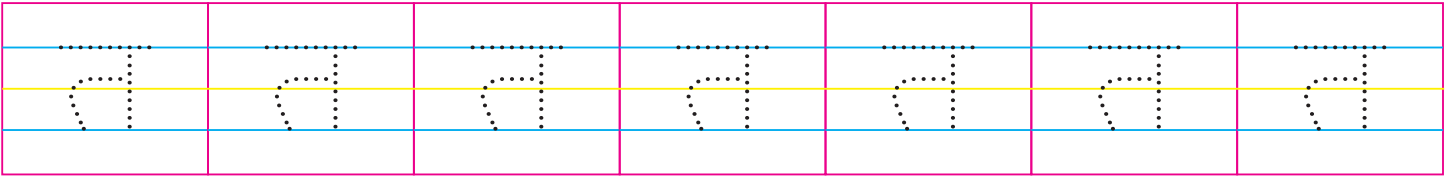
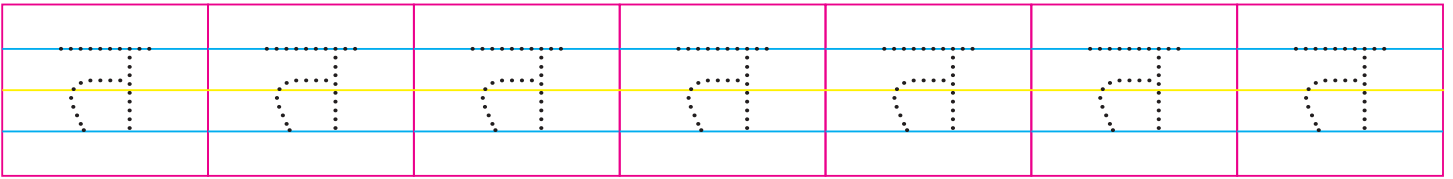
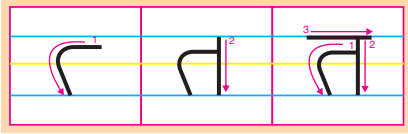

हस्ताक्षर :

दिनांक: ___/___/___

कक्षा कार्य / गृह कार्य

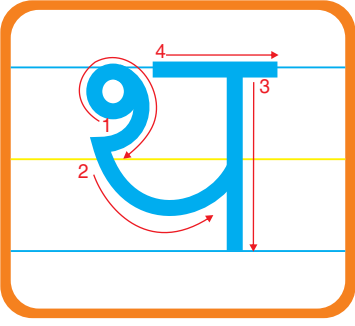

चित्र देखकर रंग भरिए-

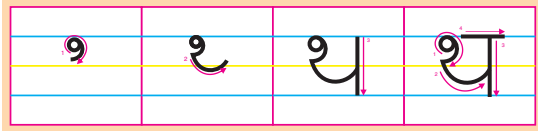

थर्मस

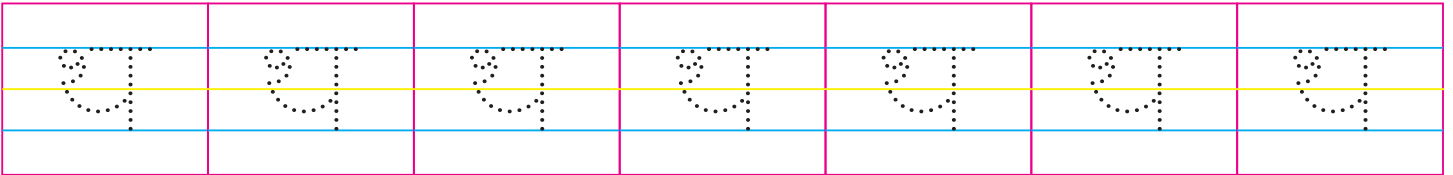
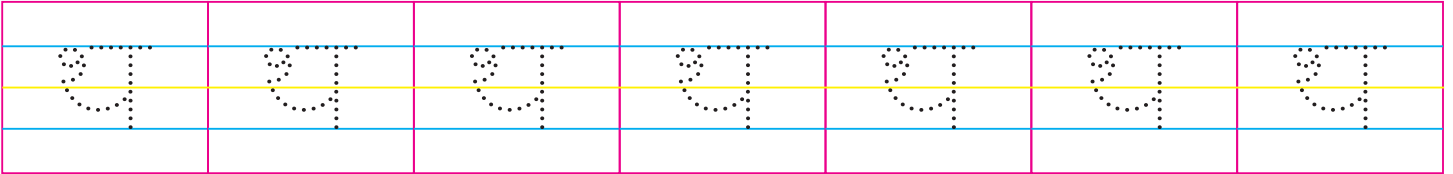
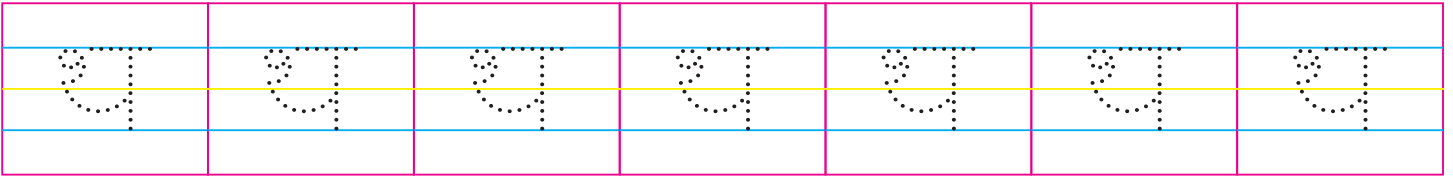
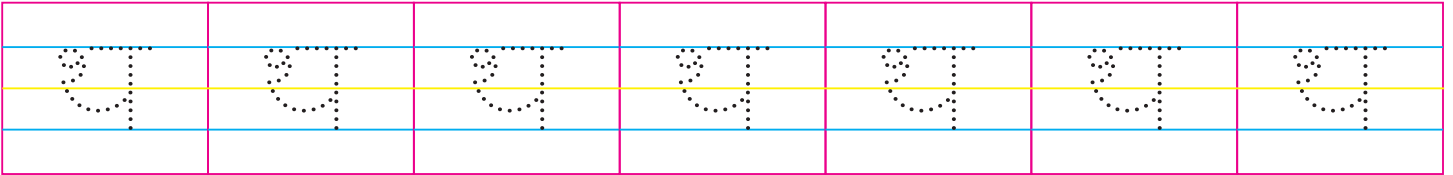
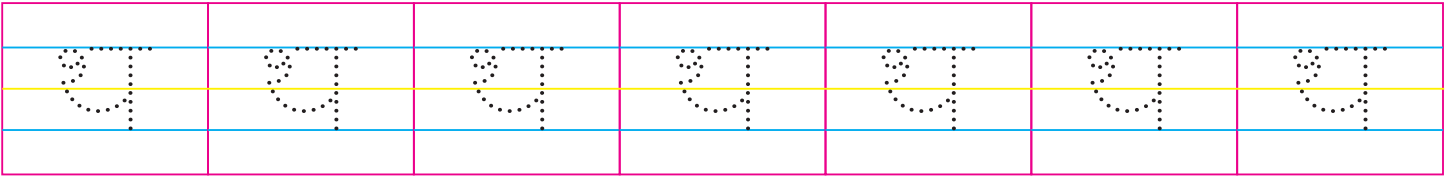
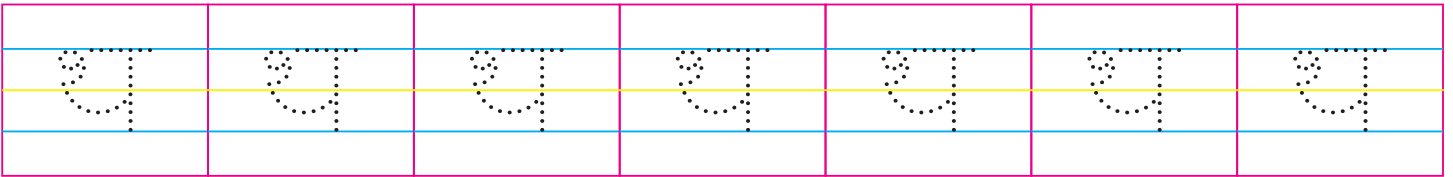

हस्ताक्षर :

दिनांक: ___/___/___

कक्षा कार्य / गृह कार्य

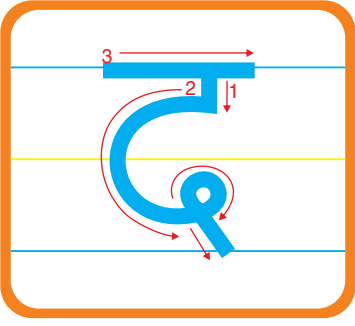

चित्र देखकर रंग भरिए-

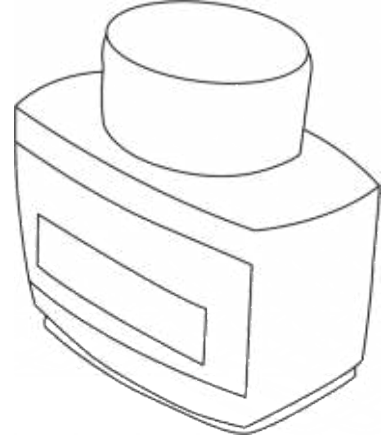

दवात

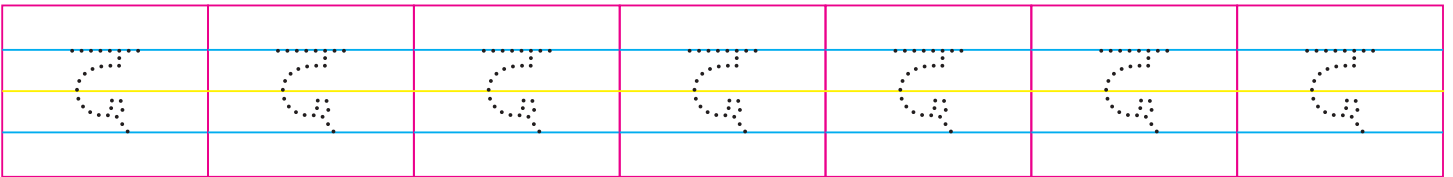
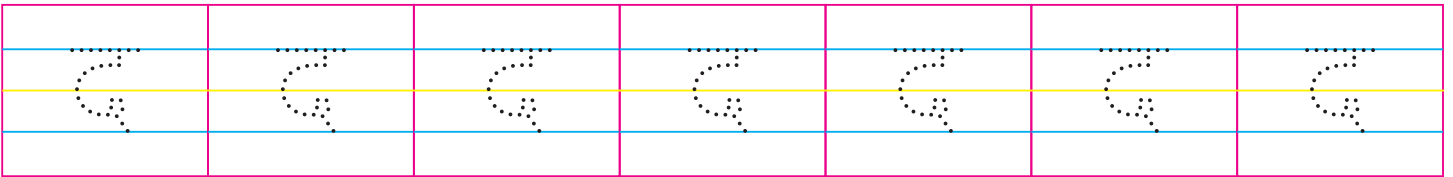
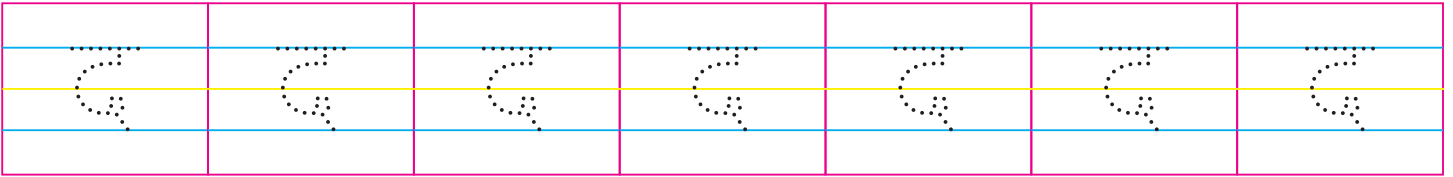
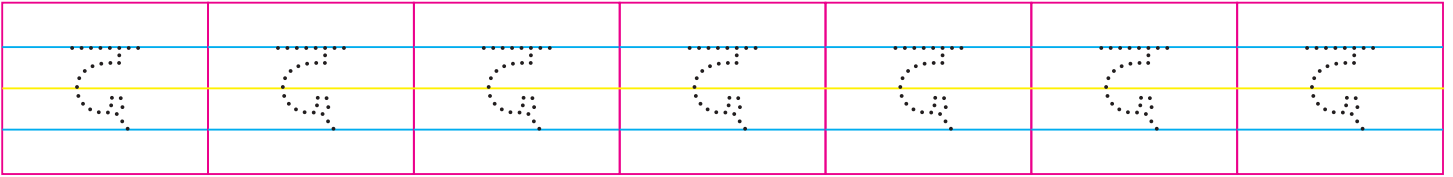
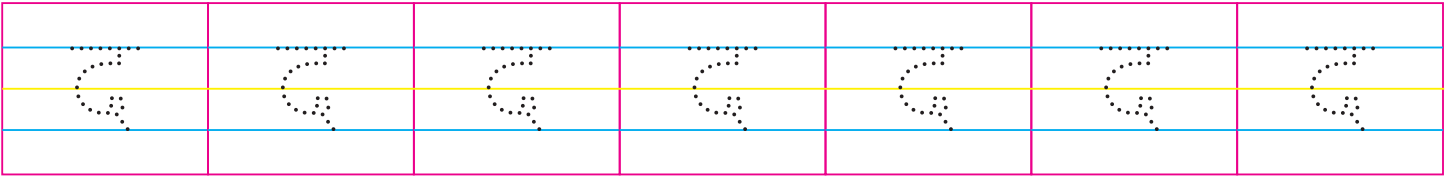
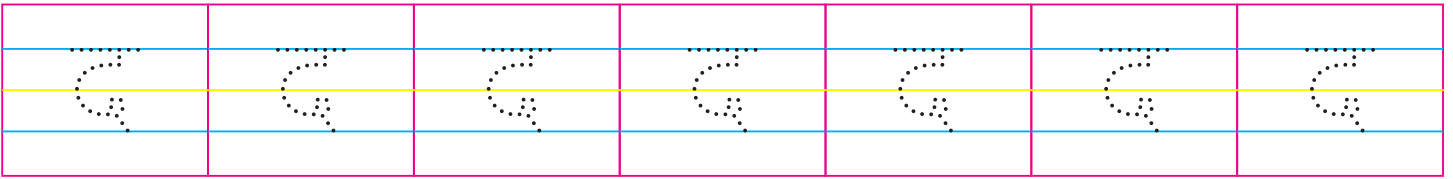
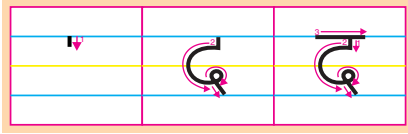

हस्ताक्षर :

दिनांक: ___/___/___

कक्षा कार्य / गृह कार्य

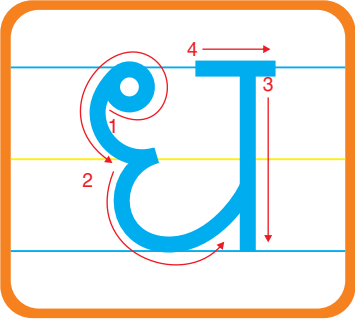

धन

चित्र देखकर रंग भरिए-

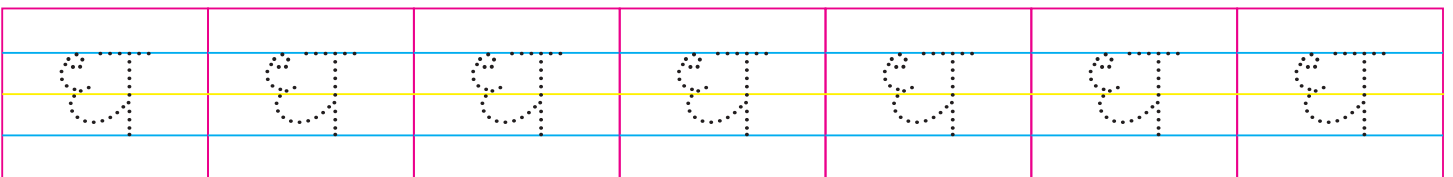
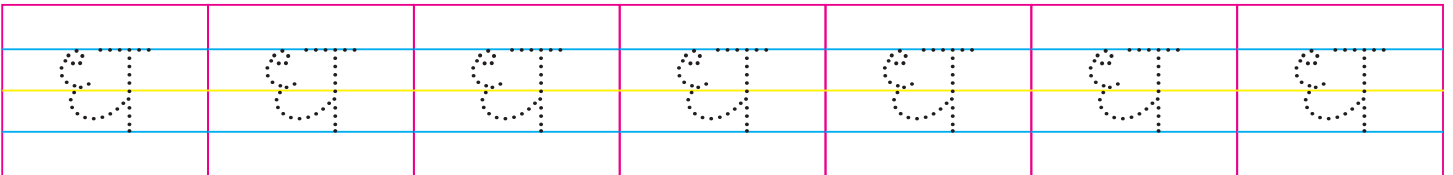
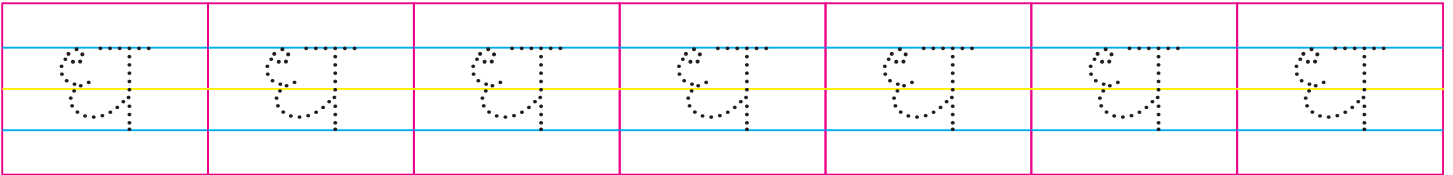
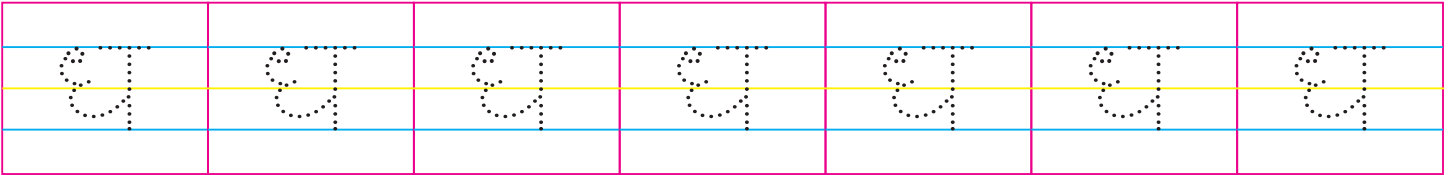
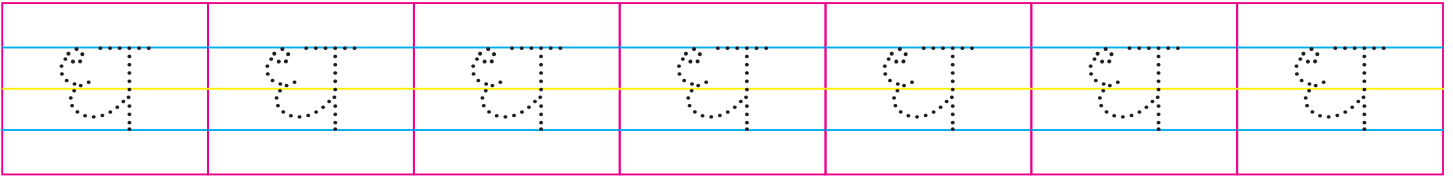
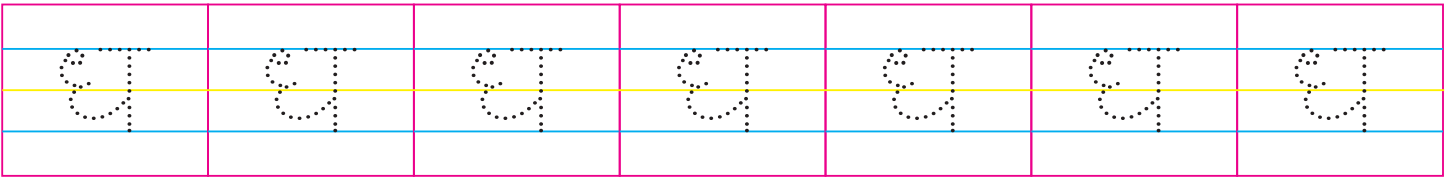
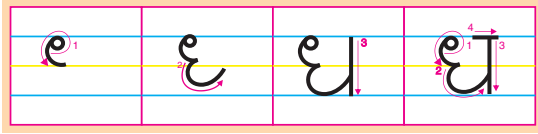

हस्ताक्षर :

दिनांक: ___/___/___

कक्षा कार्य / गृह कार्य

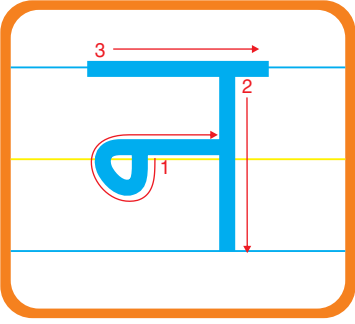

नल

चित्र देखकर रंग भरिए-

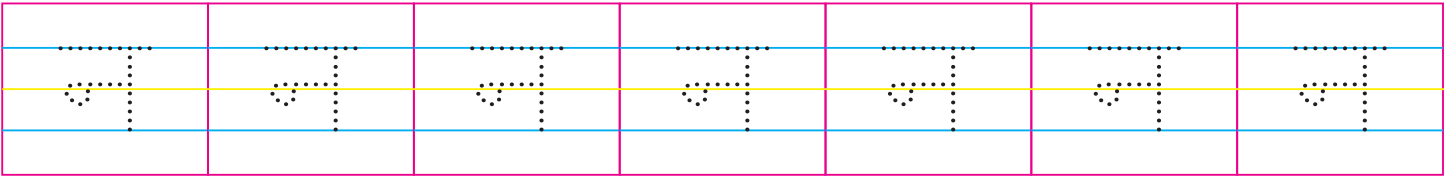
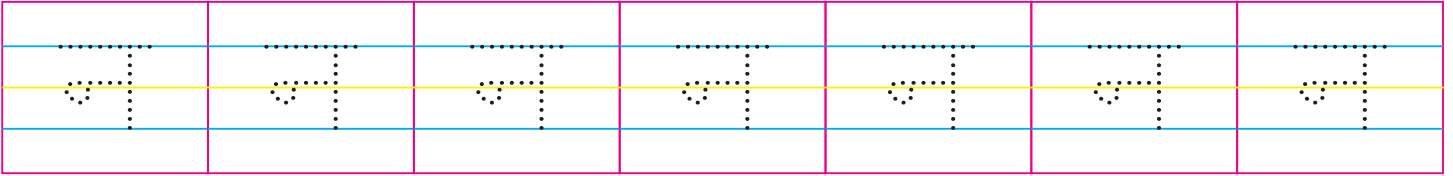
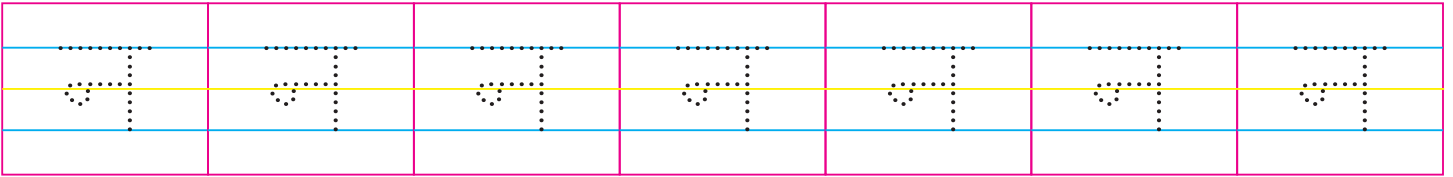
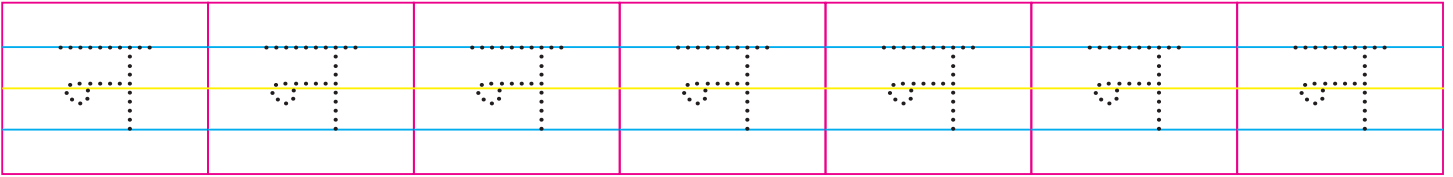
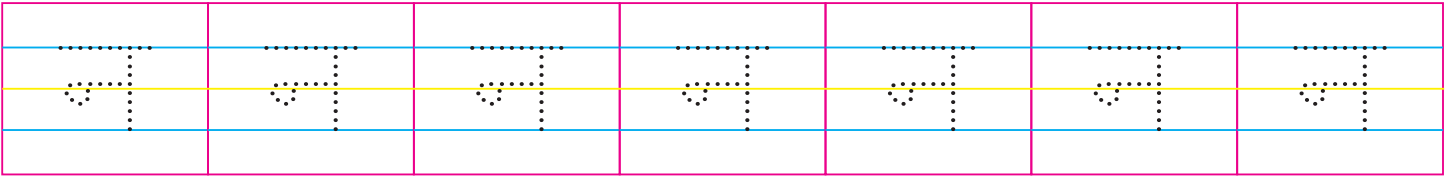
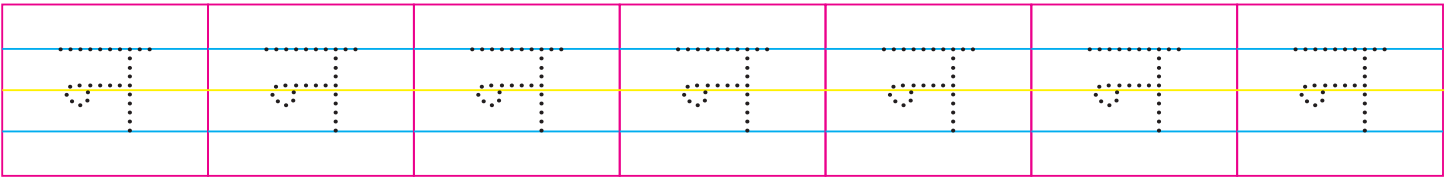
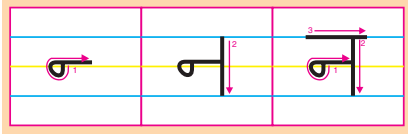
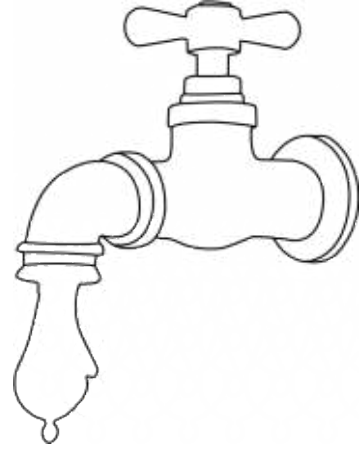

हस्ताक्षर :

दिनांक: ___/___/___

कक्षा कार्य ○ / गृह कार्य ○

अक्षर देखकर खाली स्थान में वही अक्षर लिखिये:

ट		ठ		ड		ढ	
ण		त		थ		द	
ध		न					

चित्र देखकर शब्द पूरा करें:



न		ध		झं		घ	
---	--	---	--	----	--	---	--

ट से न तक लिखें:

हस्ताक्षर :

दिनांक: ___/___/___

कक्षा कार्य / गृह कार्य

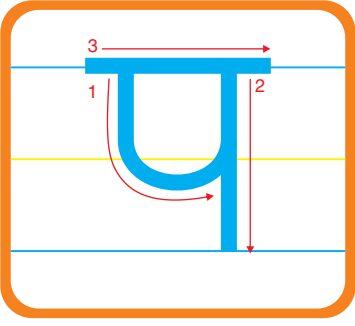

पतंग

चित्र देखकर रंग भरिए-

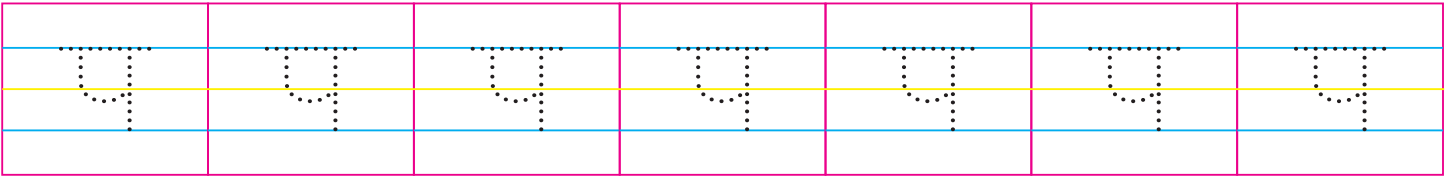
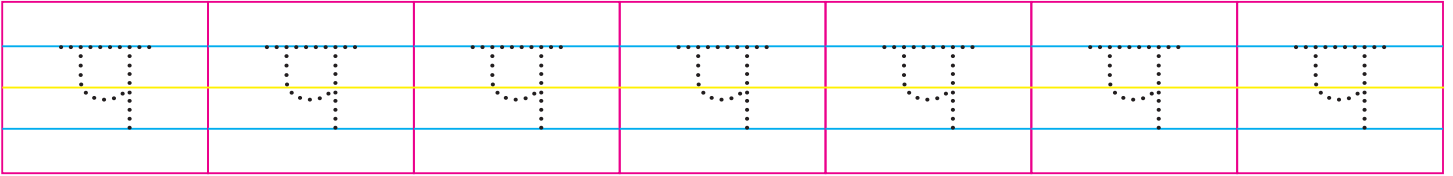
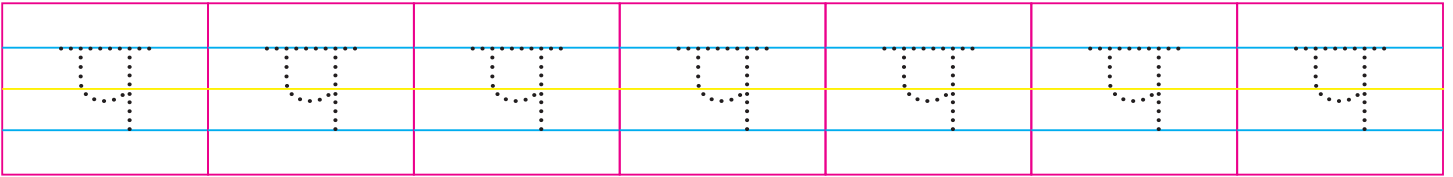
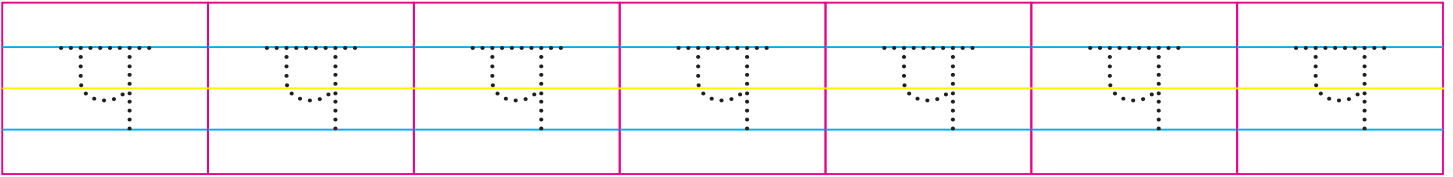
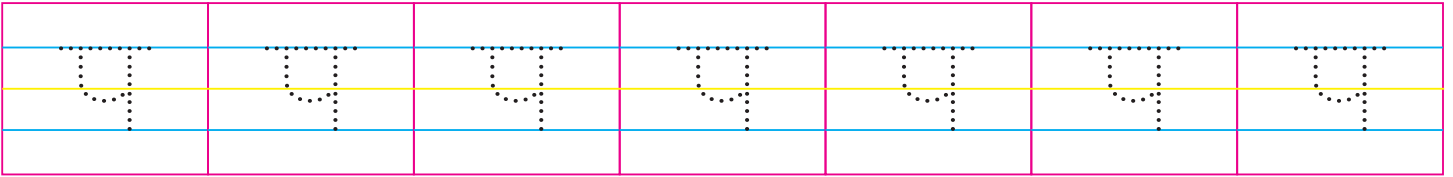
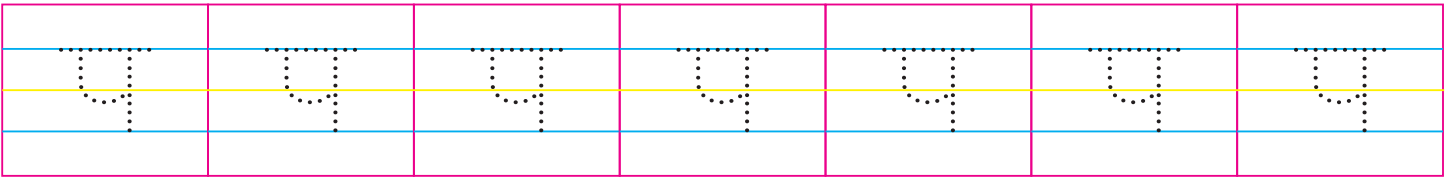
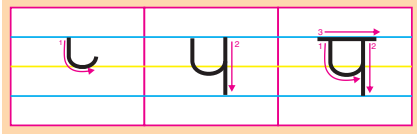
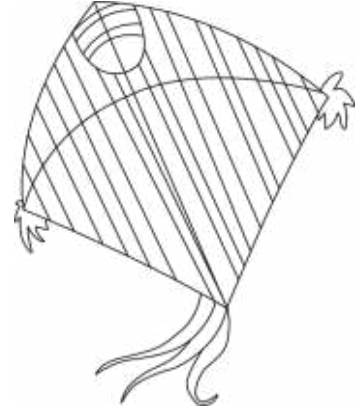

हस्ताक्षर :

दिनांक: ___/___/___

कक्षा कार्य / गृह कार्य

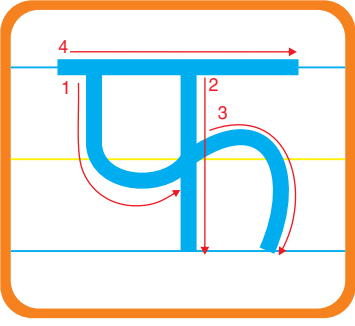

चित्र देखकर रंग भरिए-

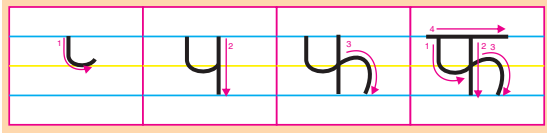

फल

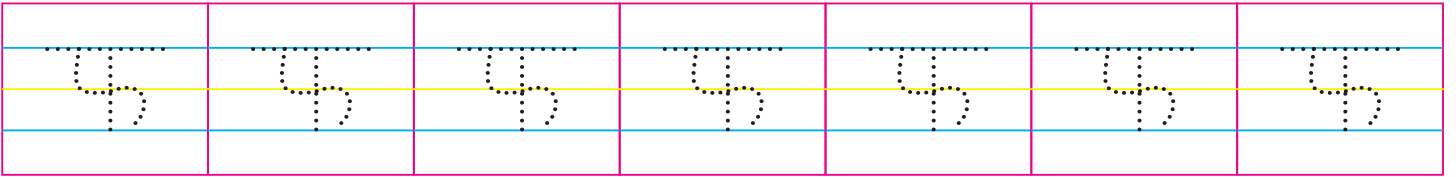
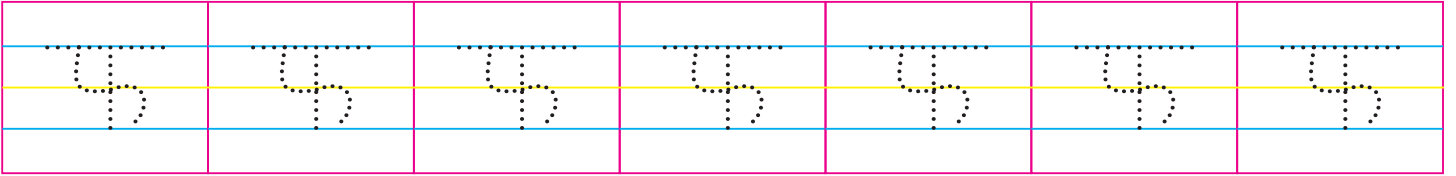
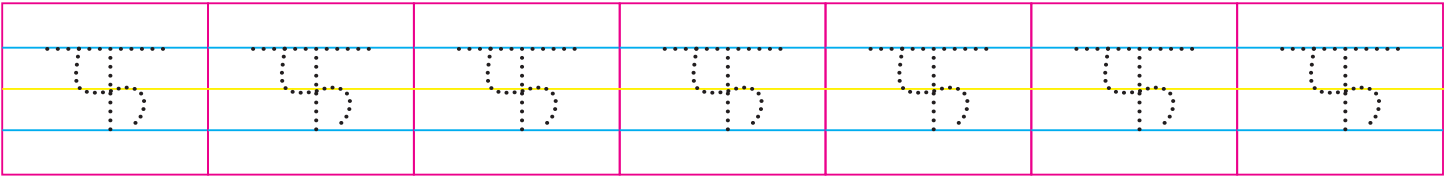
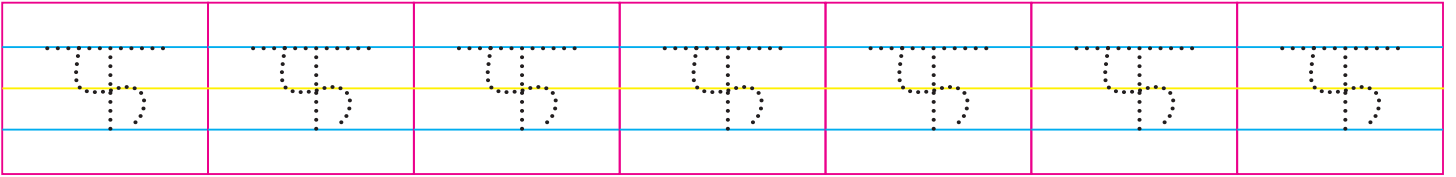
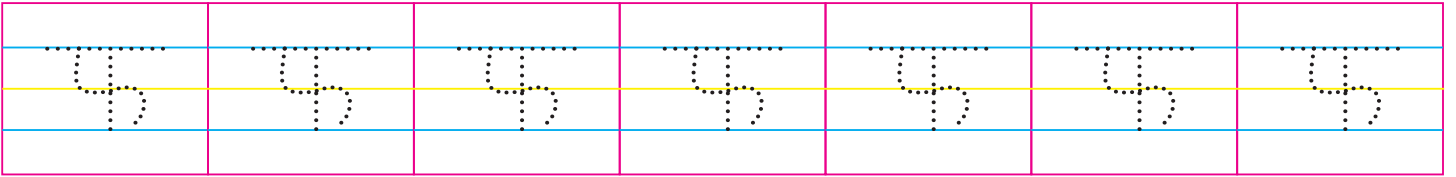
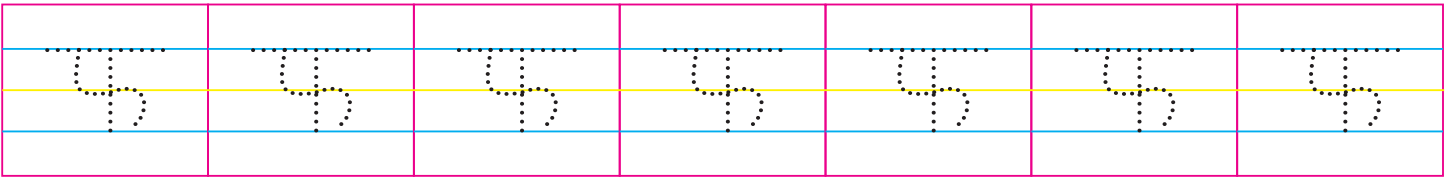

हस्ताक्षर :

दिनांक: ___/___/___

कक्षा कार्य / गृह कार्य

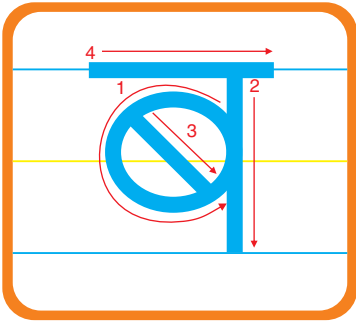

बस

चित्र देखकर रंग भरिए-

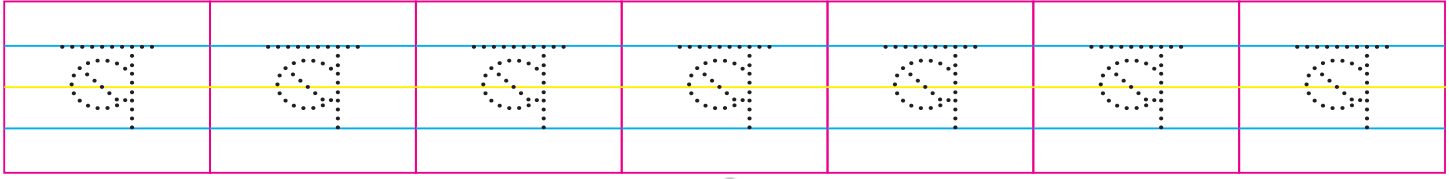
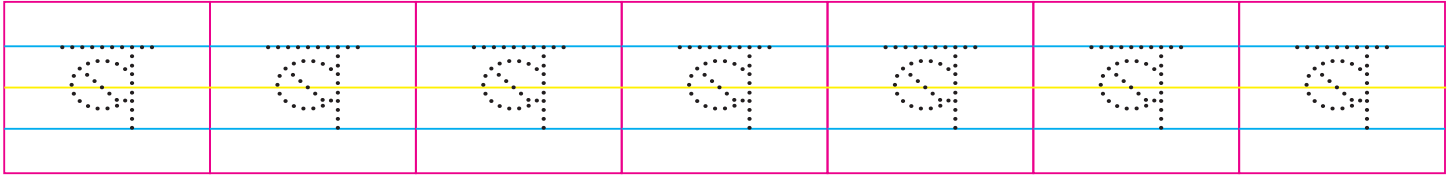
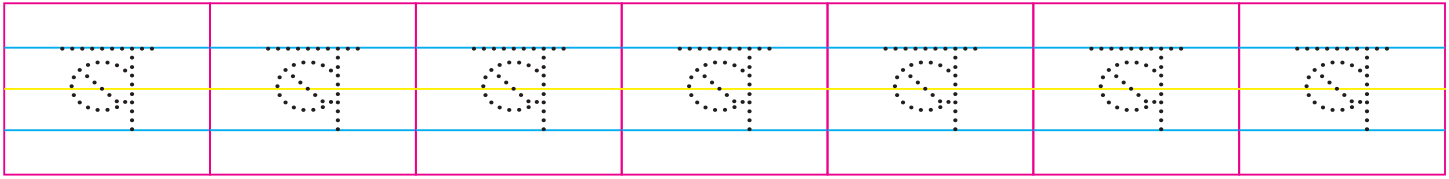
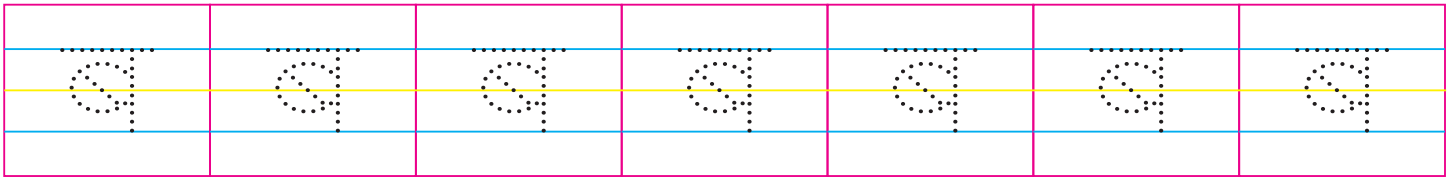
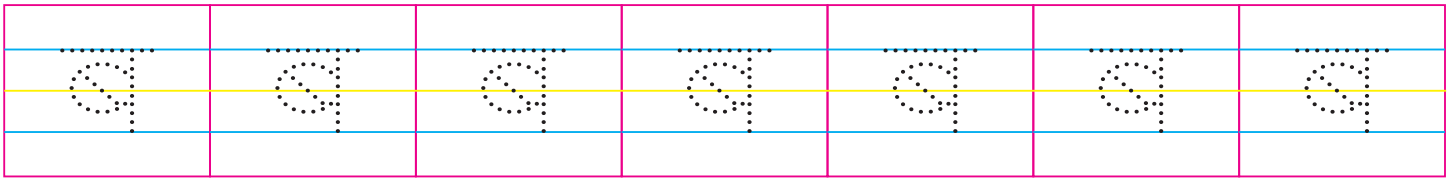
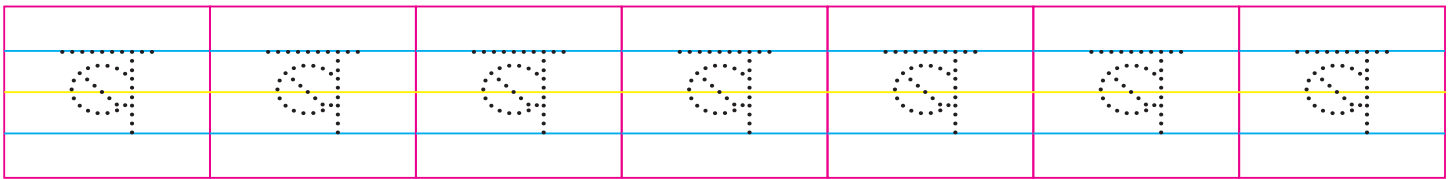
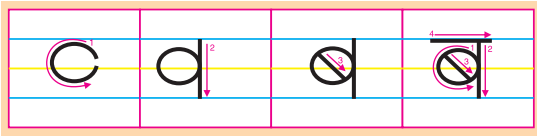
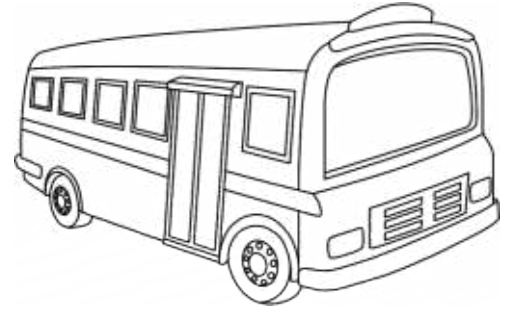

हस्ताक्षर :

दिनांक: ___/___/___

कक्षा कार्य / गृह कार्य

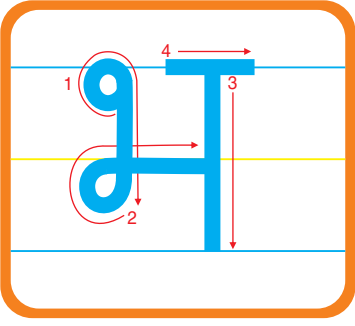

चित्र देखकर रंग भरिए-

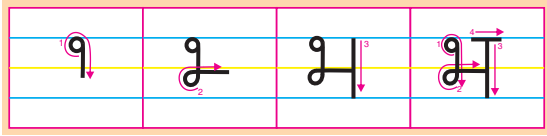
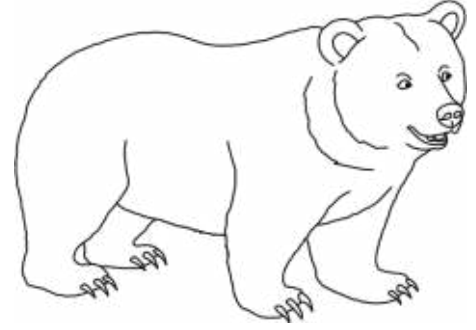

भालू

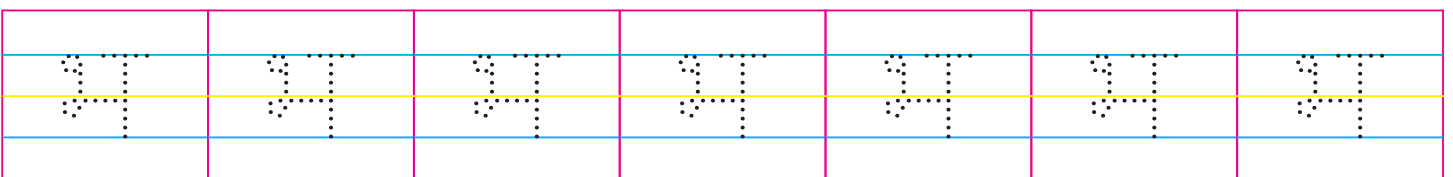
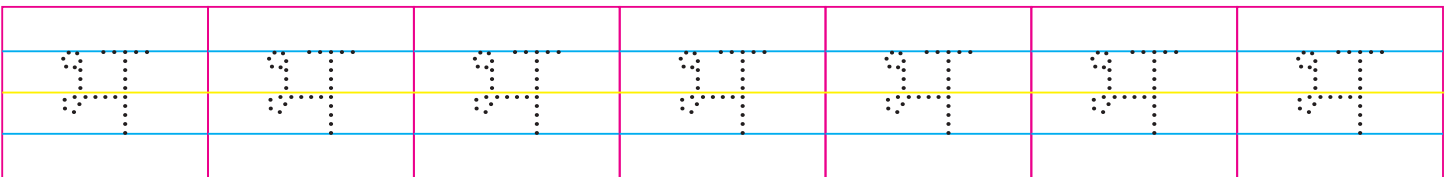
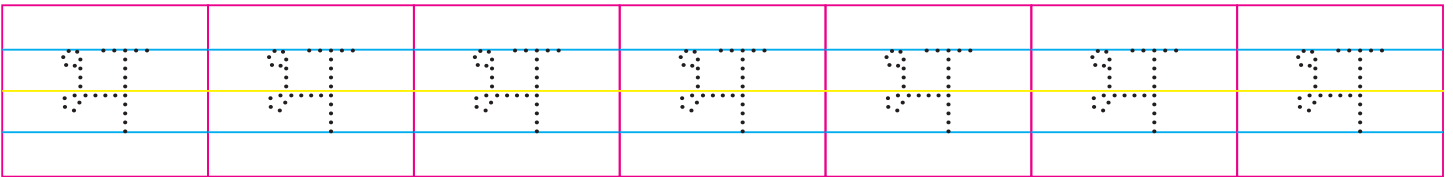
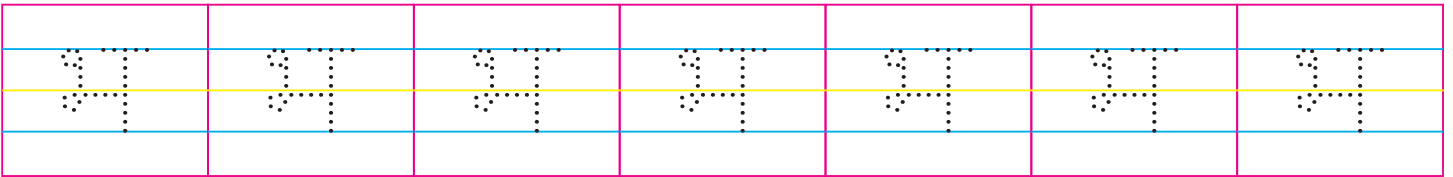
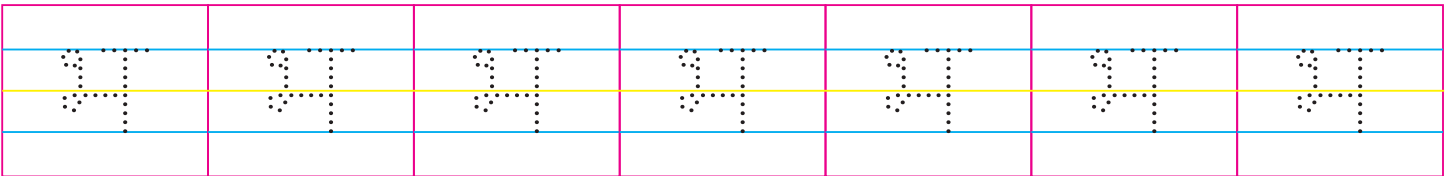
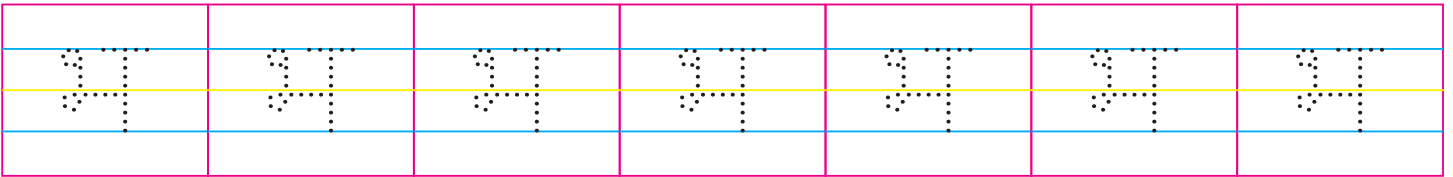

हस्ताक्षर :

दिनांक: ___/___/___

कक्षा कार्य / गृह कार्य

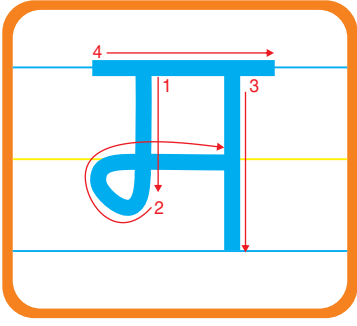

चित्र देखकर रंग भरिए-

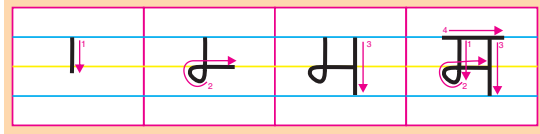

मछली

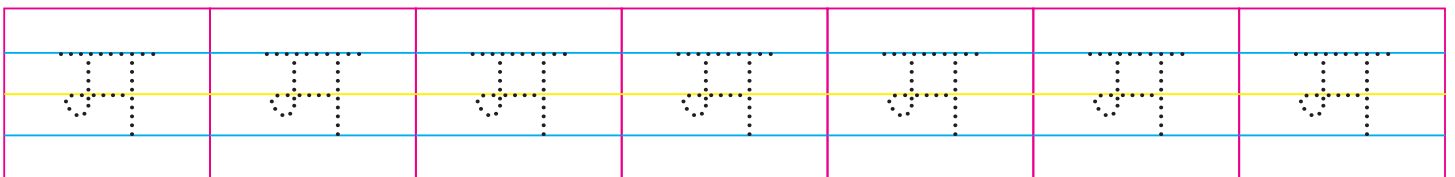
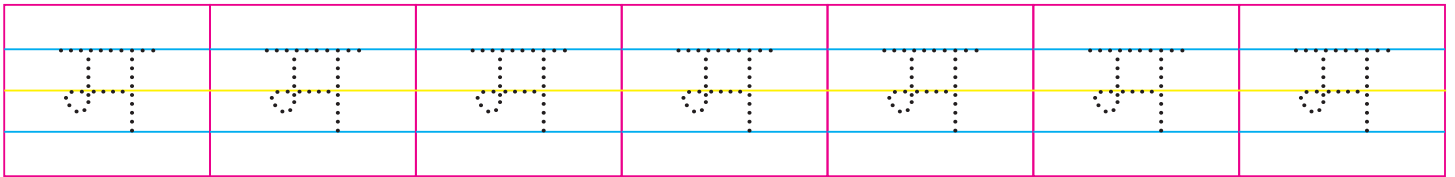
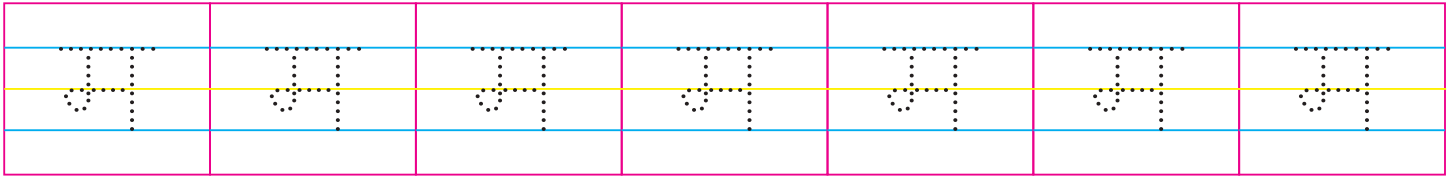
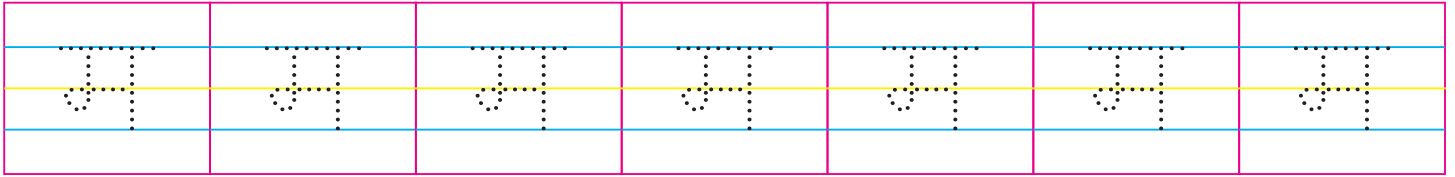
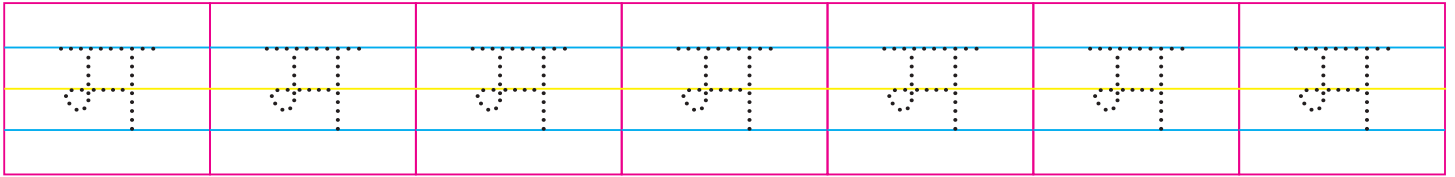
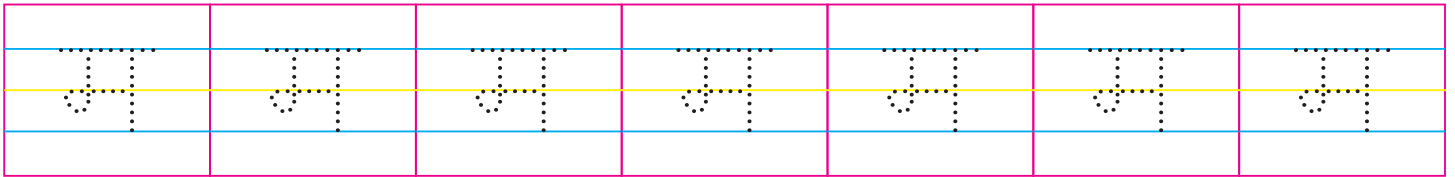

हस्ताक्षर :

दिनांक: ___/___/___

कक्षा कार्य / गृह कार्य

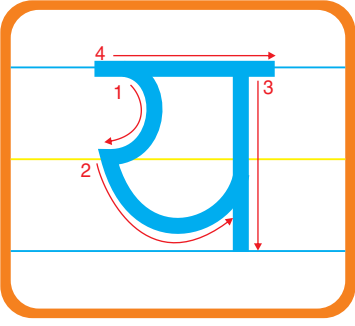

चित्र देखकर रंग भरिए-

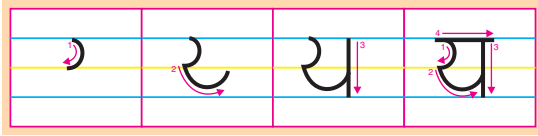

यज्ञ

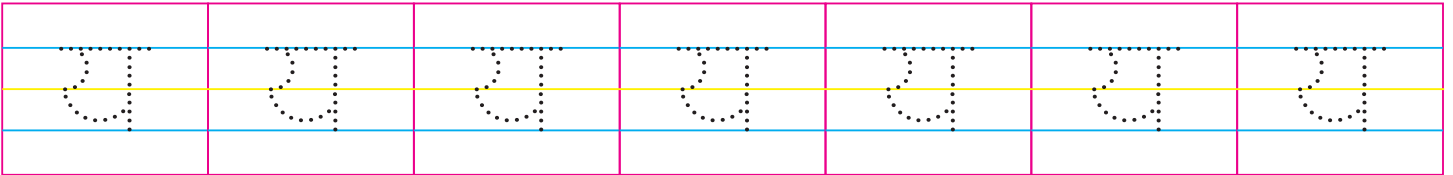
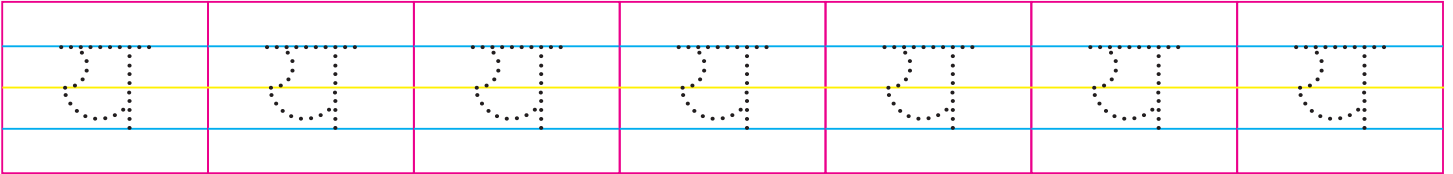
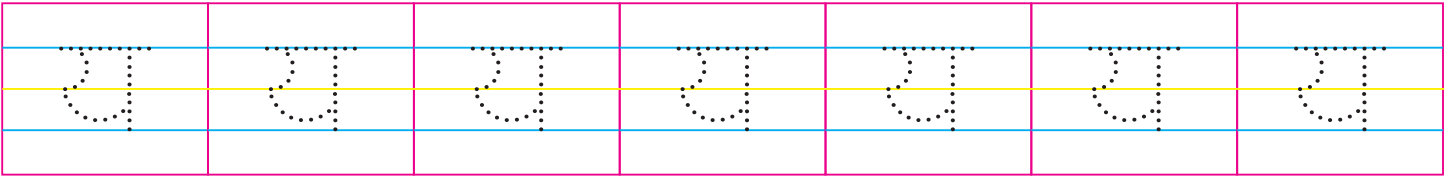
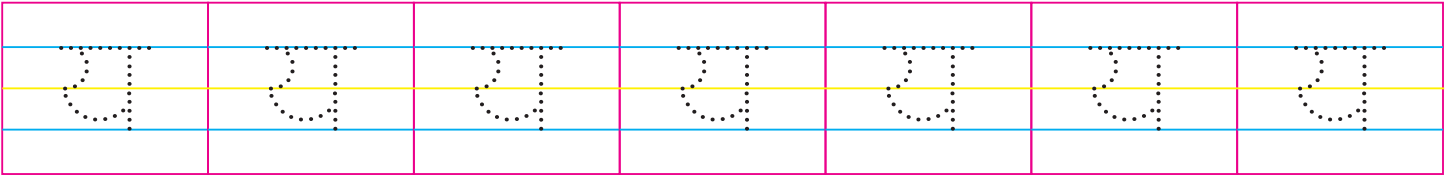
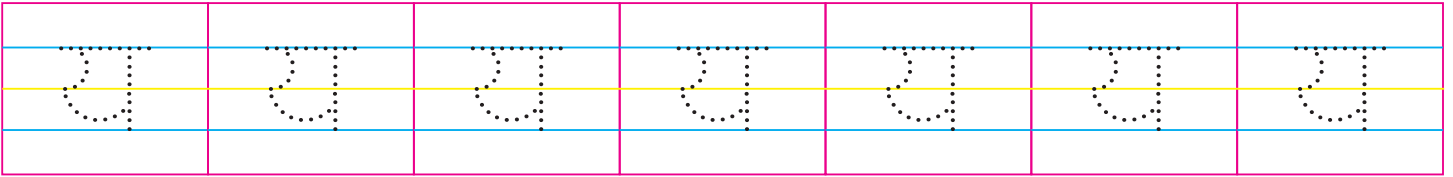
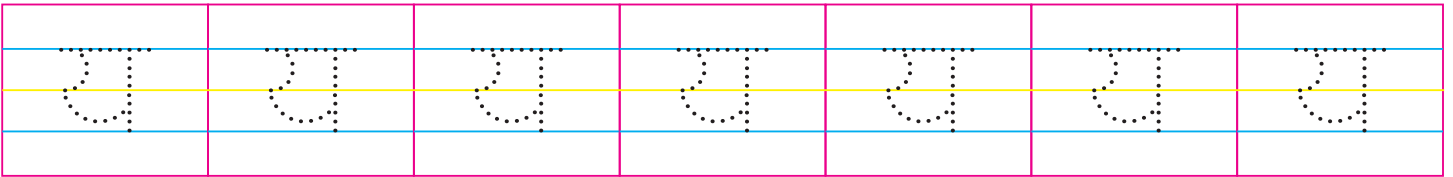

हस्ताक्षर :

दिनांक: ___/___/___

कक्षा कार्य / गृह कार्य

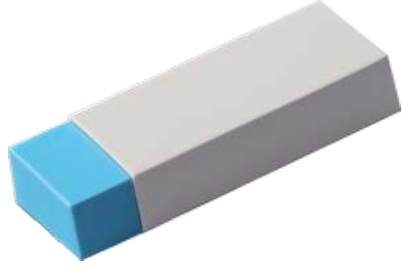
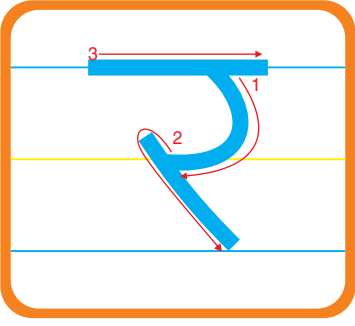

चित्र देखकर रंग भरिए-

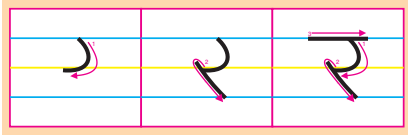
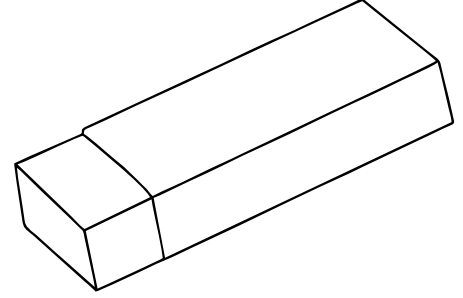

रबड़

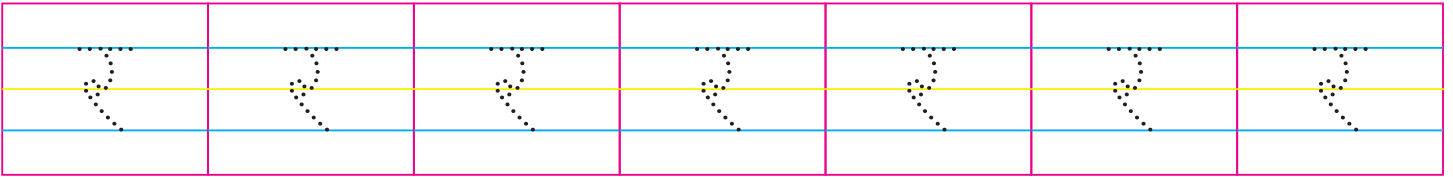
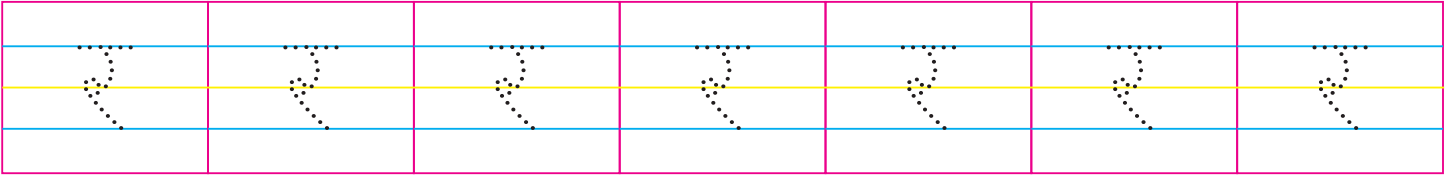
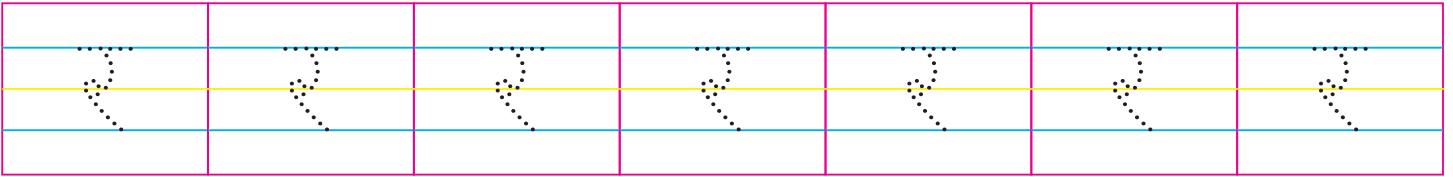
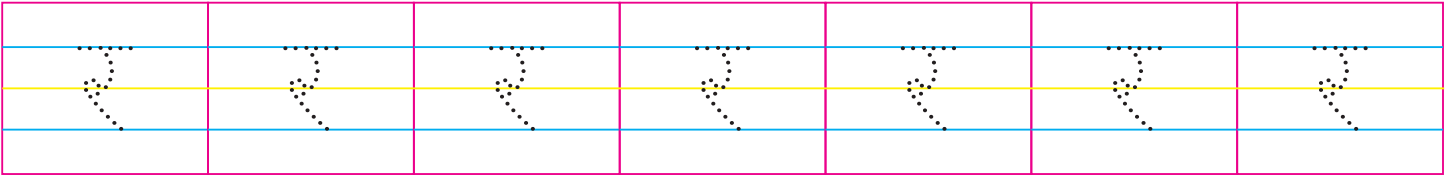
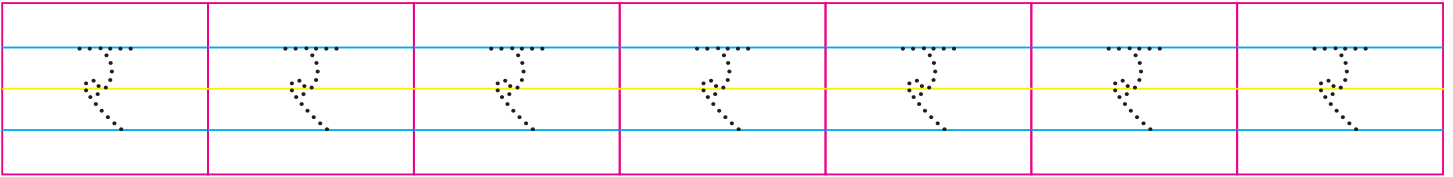
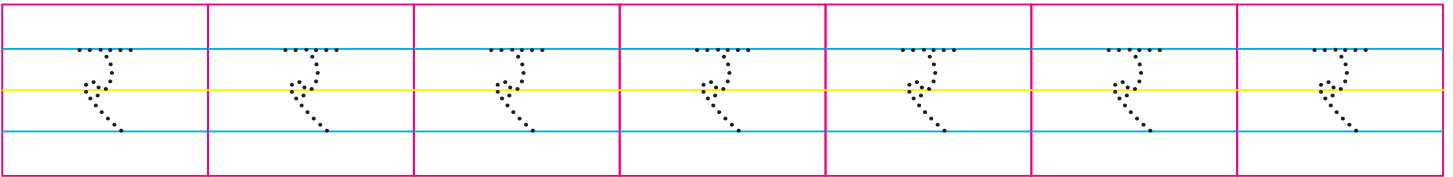

हस्ताक्षर :

दिनांक: ___/___/___

कक्षा कार्य / गृह कार्य

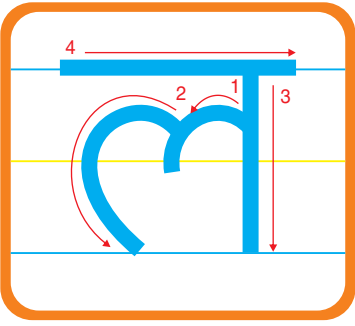

चित्र देखकर रंग भरिए-

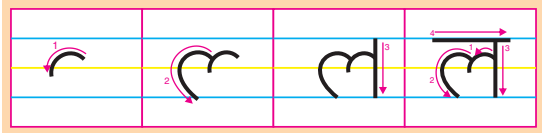

ललल

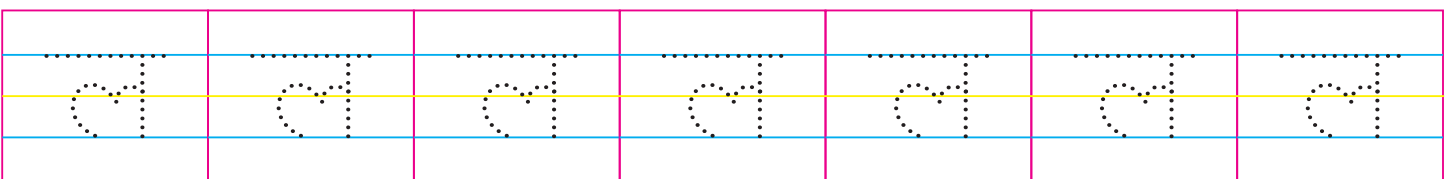
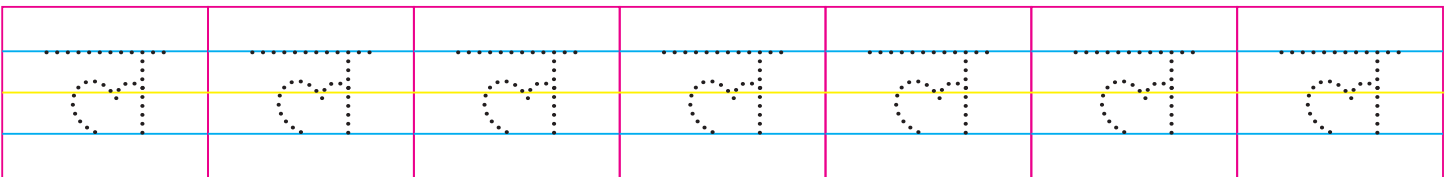
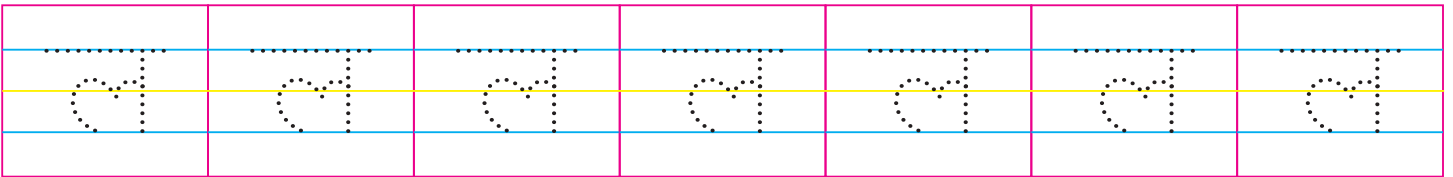
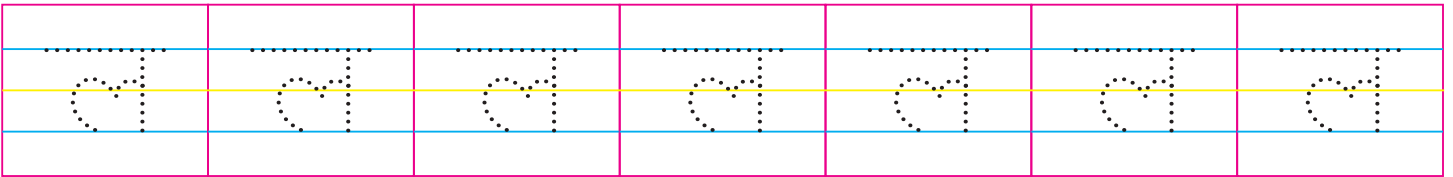
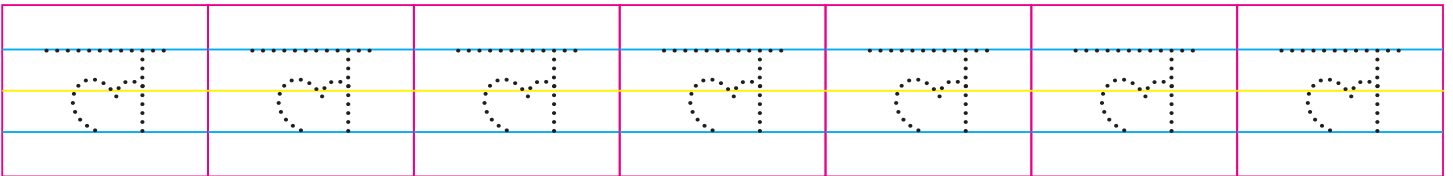
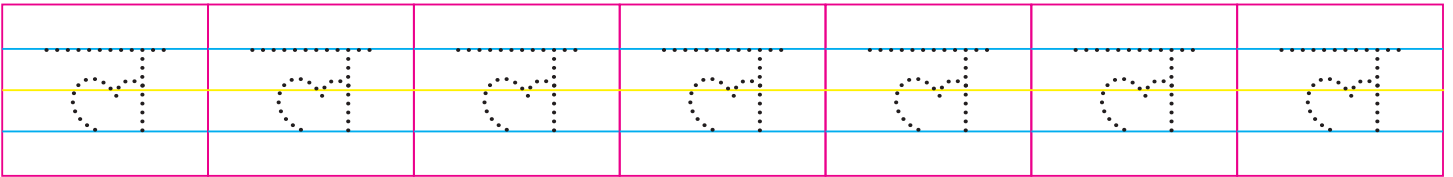

हस्ताक्षर :

दिनांक: ___/___/___

कक्षा कार्य / गृह कार्य

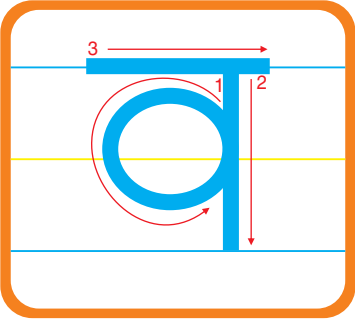

वक

चित्र देखकर रंग भरिए-

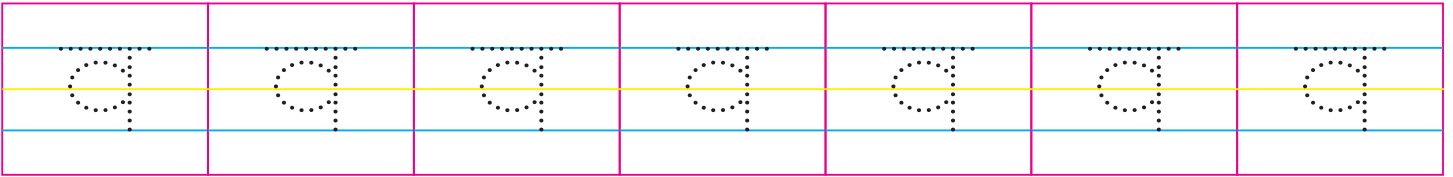
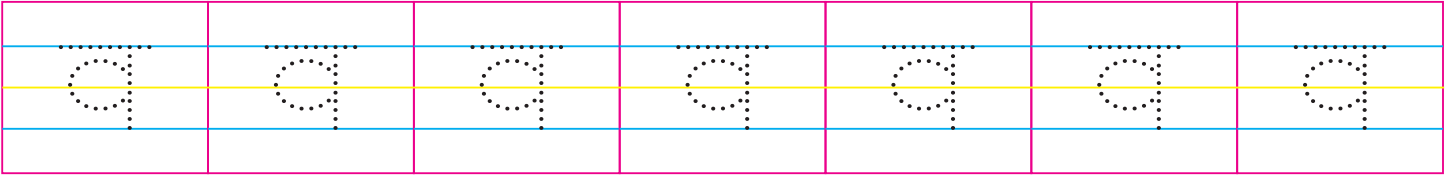
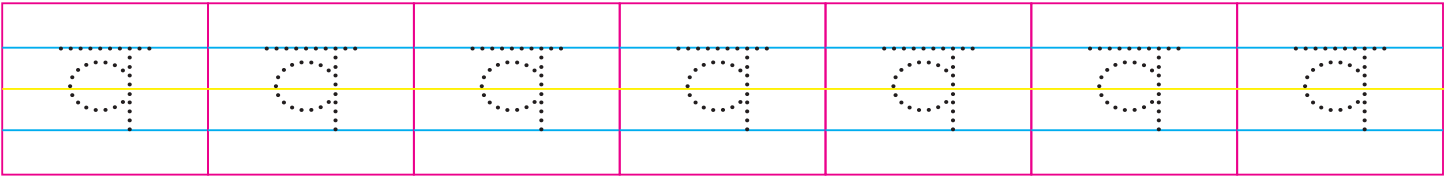
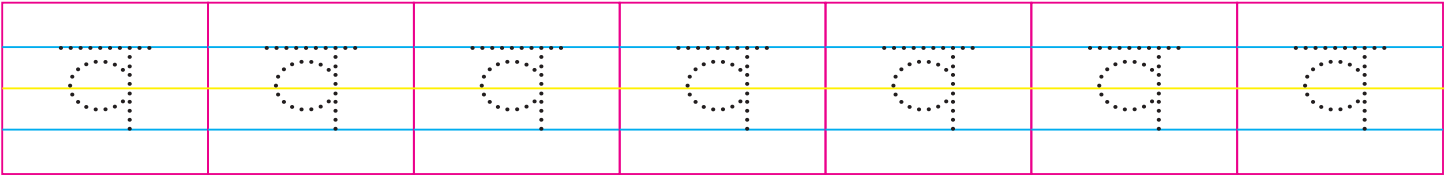
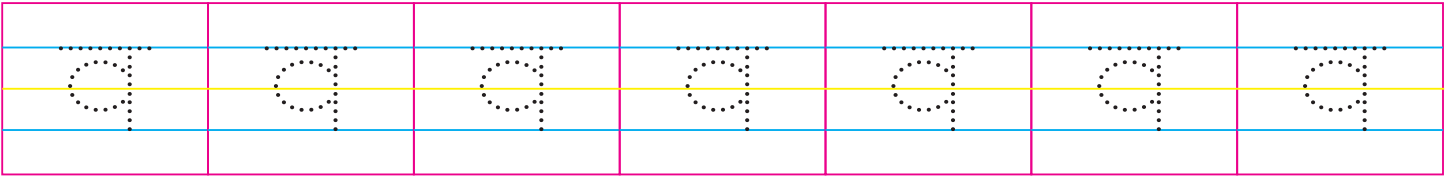
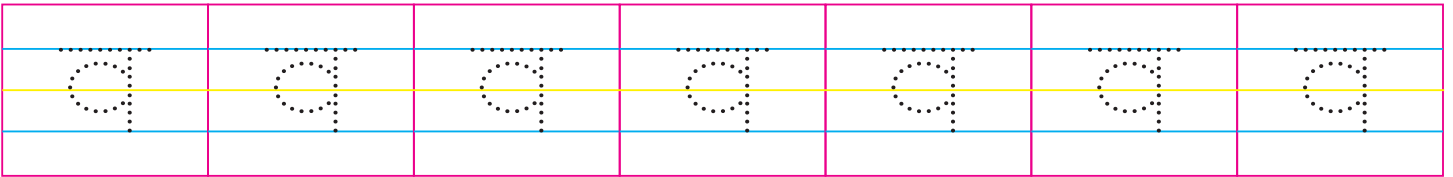
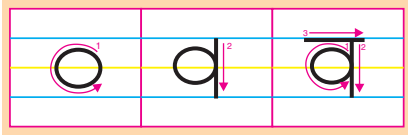

हस्ताक्षर :

दिनांक: ___/___/___

कक्षा कार्य / गृह कार्य

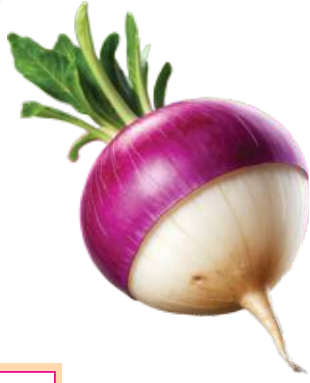
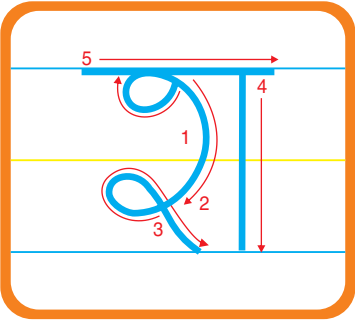

शलगम

चित्र देखकर रंग भरिए-

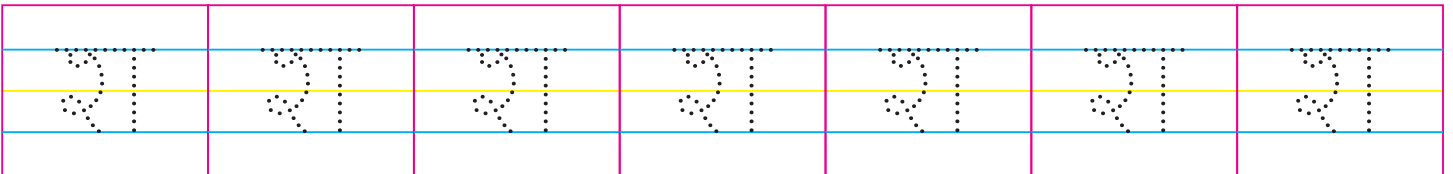
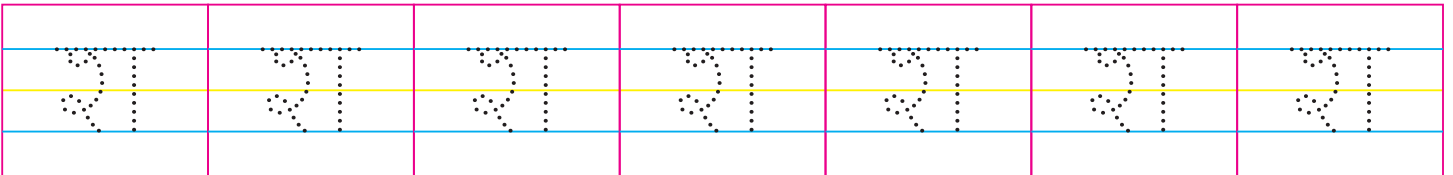
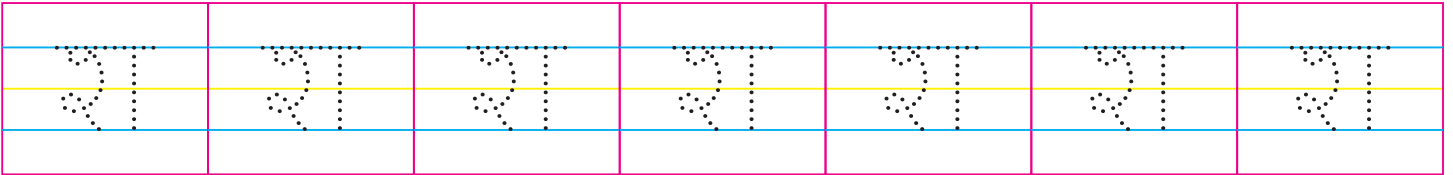
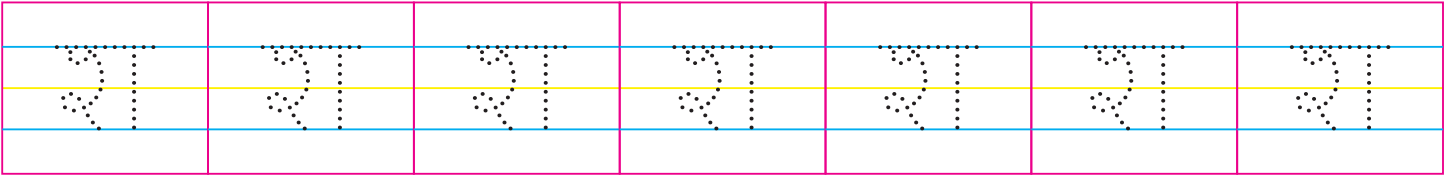
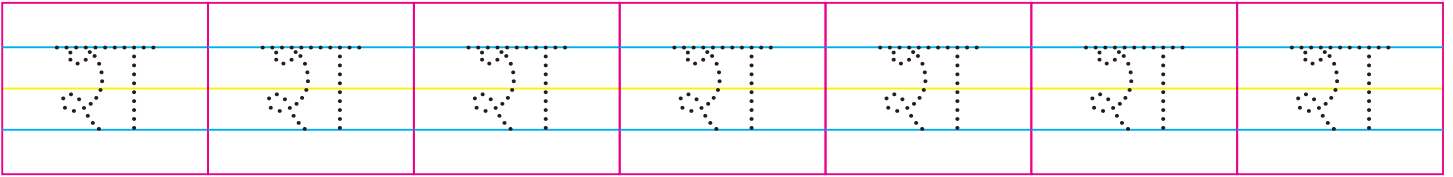
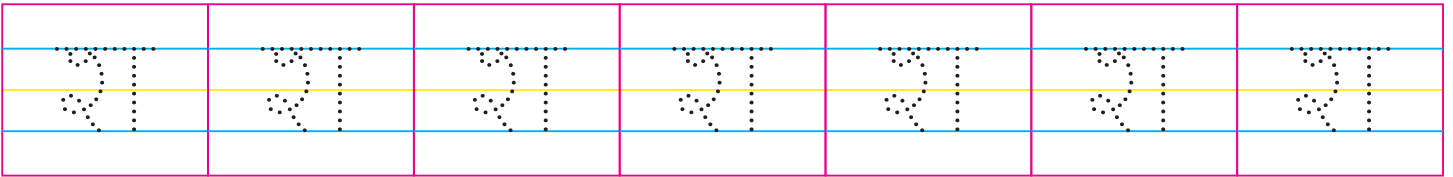
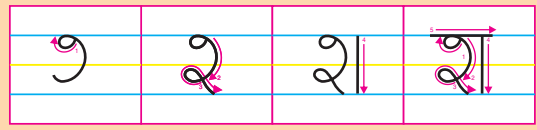
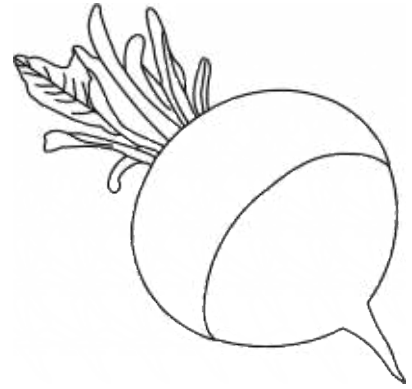

हस्ताक्षर :

दिनांक: ___/___/___

कक्षा कार्य / गृह कार्य

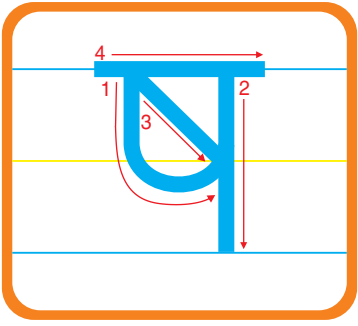

षट्कोण

चित्र देखकर रंग भरिए-

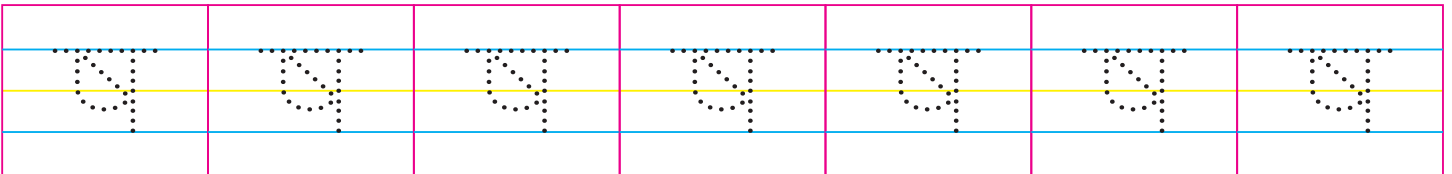
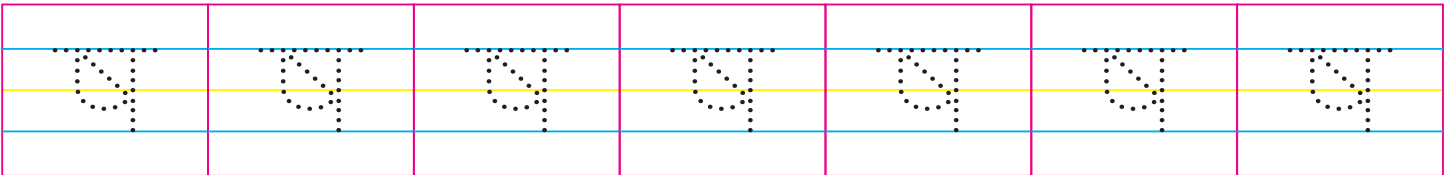
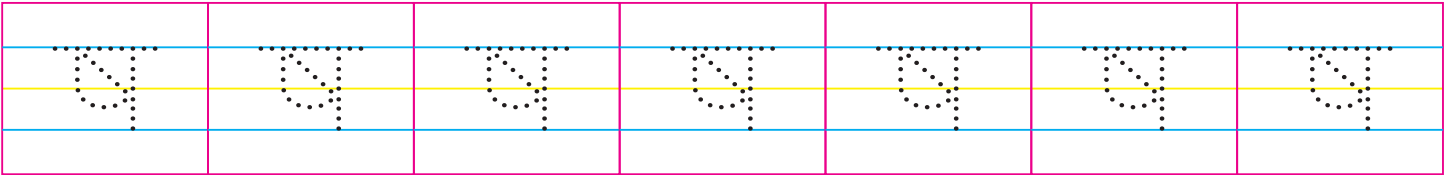
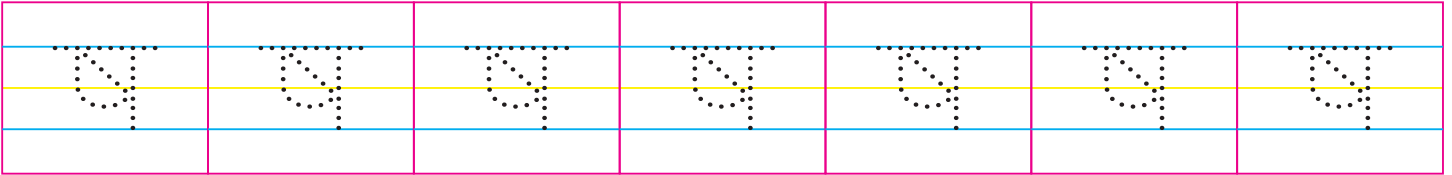
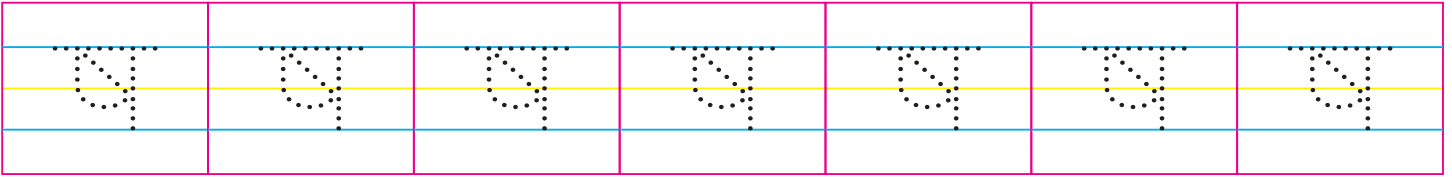
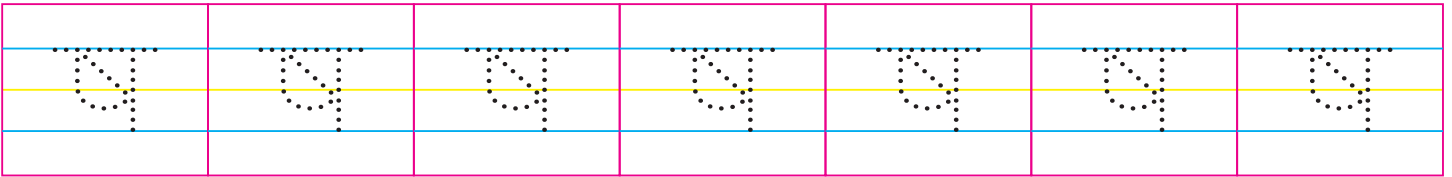
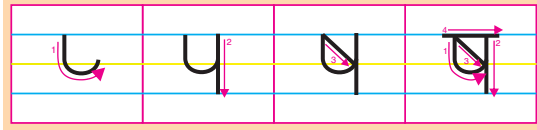
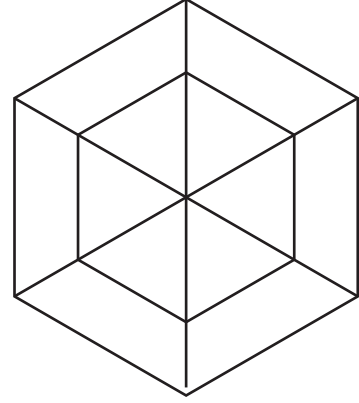

हस्ताक्षर :

दिनांक: ___/___/___

कक्षा कार्य / गृह कार्य

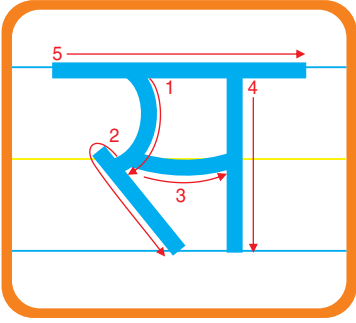

सपेरा

चित्र देखकर रंग भरिए-

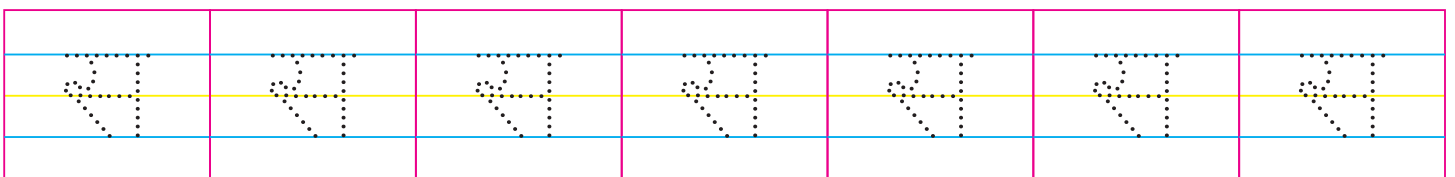
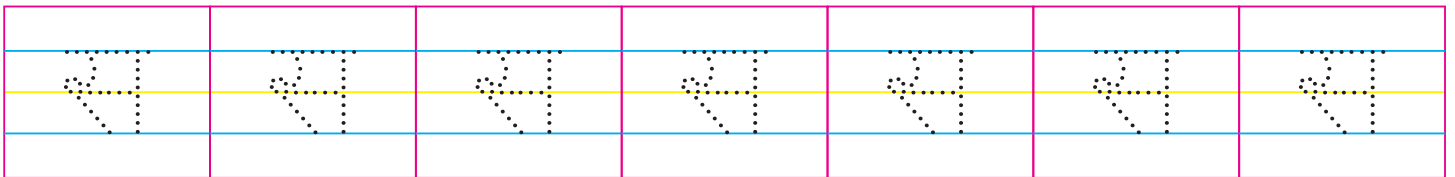
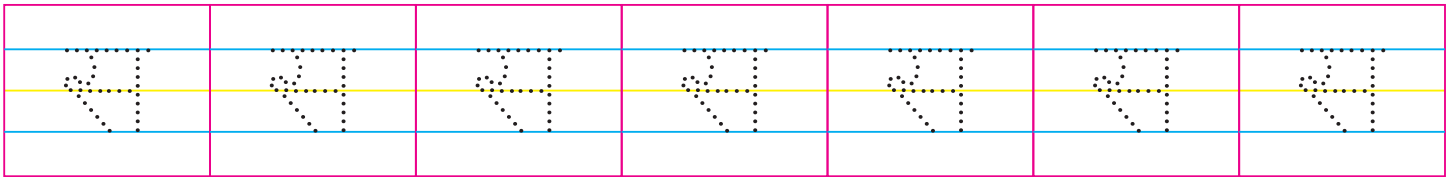
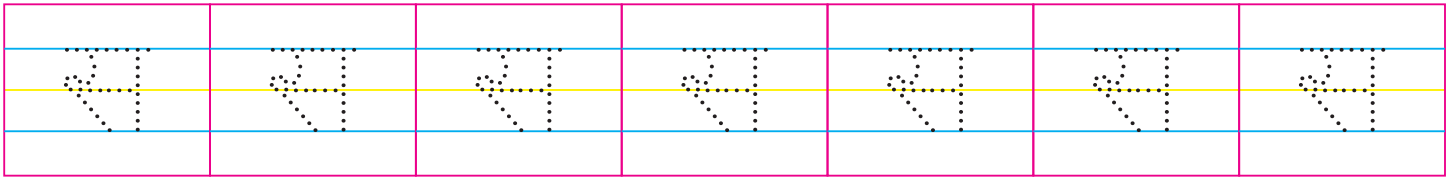
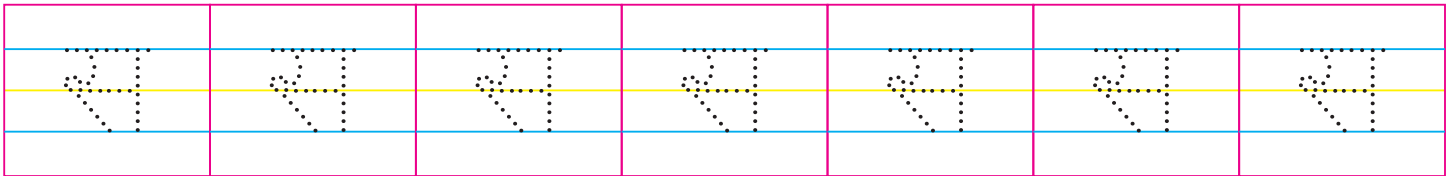
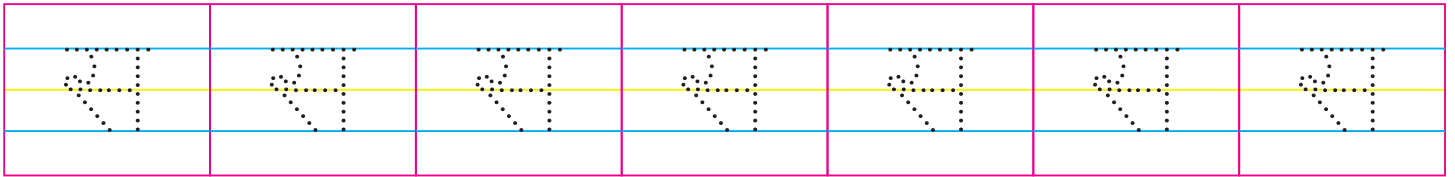
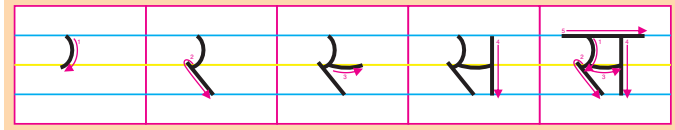

हस्ताक्षर :

दिनांक: ___/___/___

कक्षा कार्य / गृह कार्य

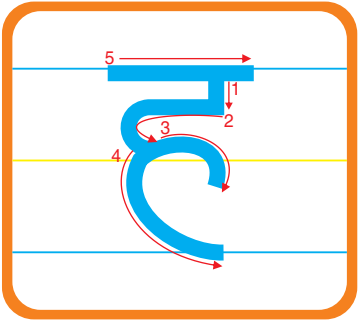

हाथी

चित्र देखकर रंग भरिए-

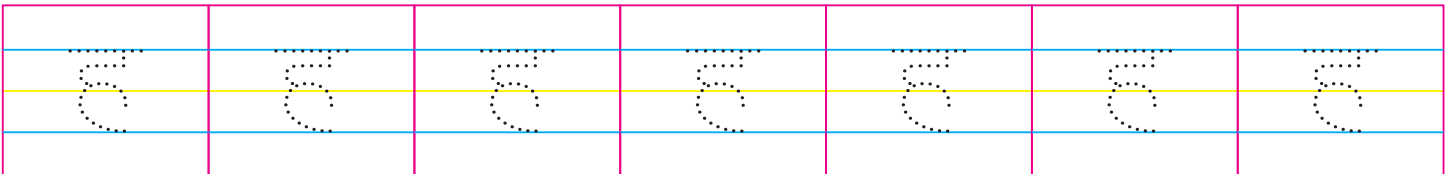
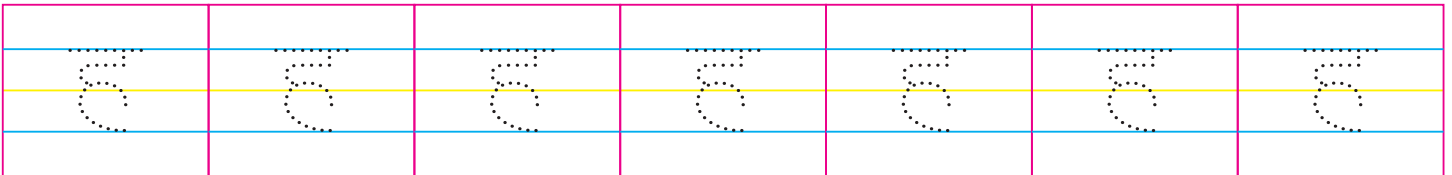
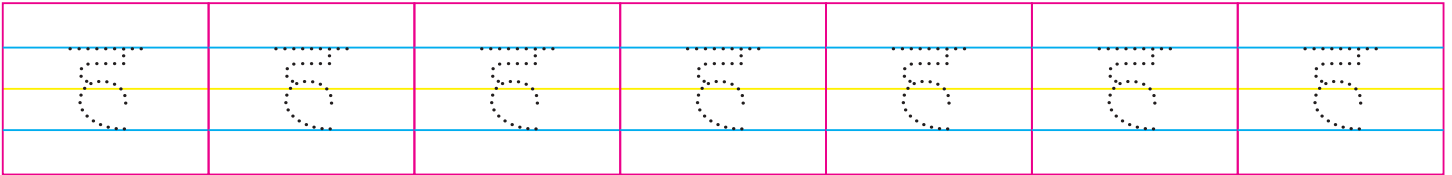
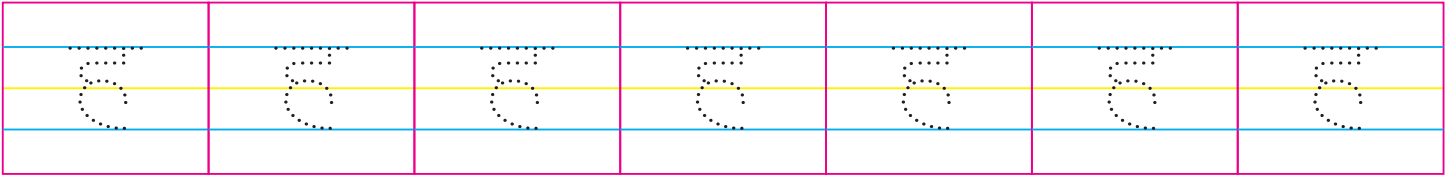
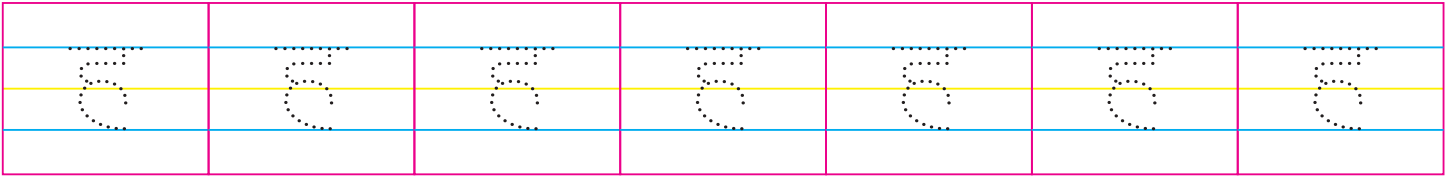
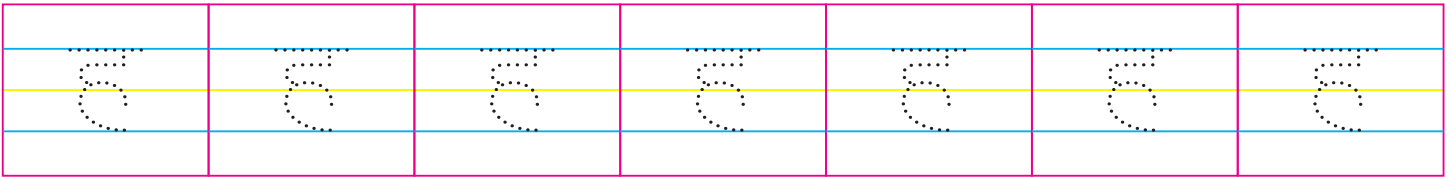
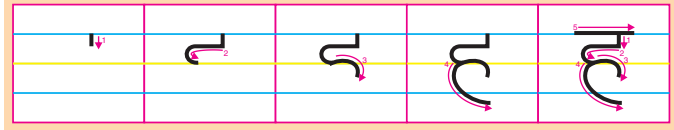
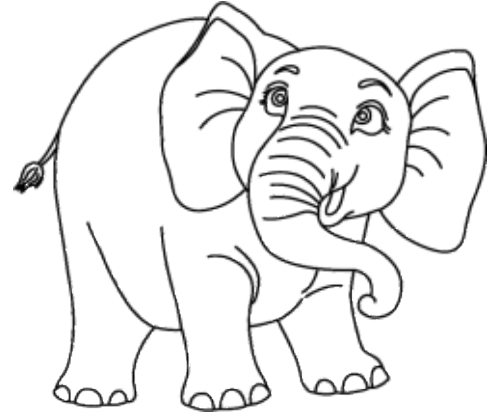

हस्ताक्षर :

दिनांक: ___/___/___

कक्षा कार्य / गृह कार्य

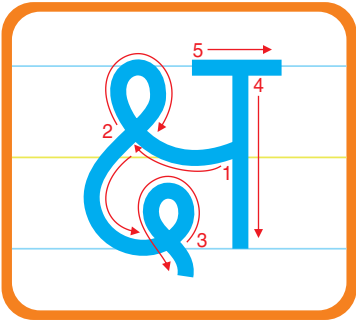

क्षत्रिय

चित्र देखकर रंग भरिए-

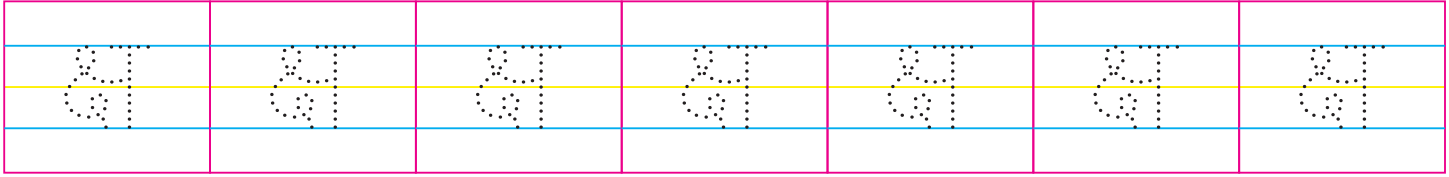
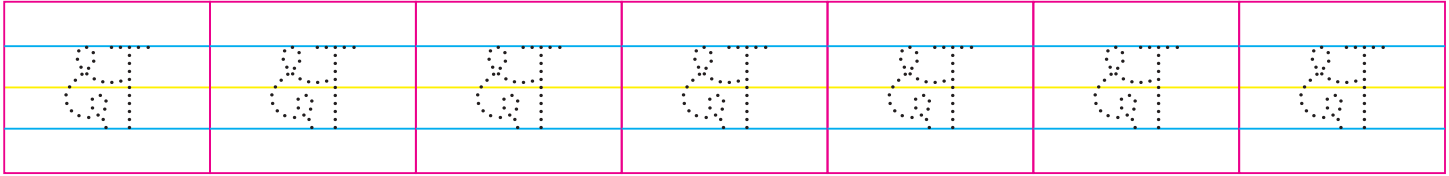
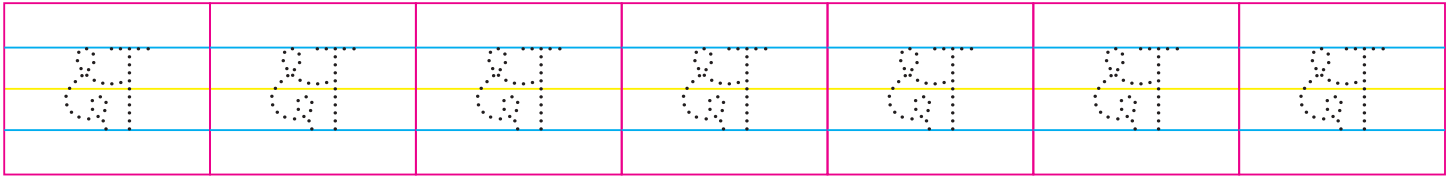
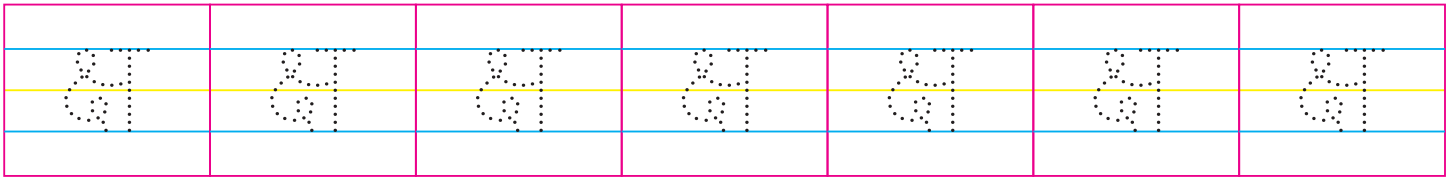
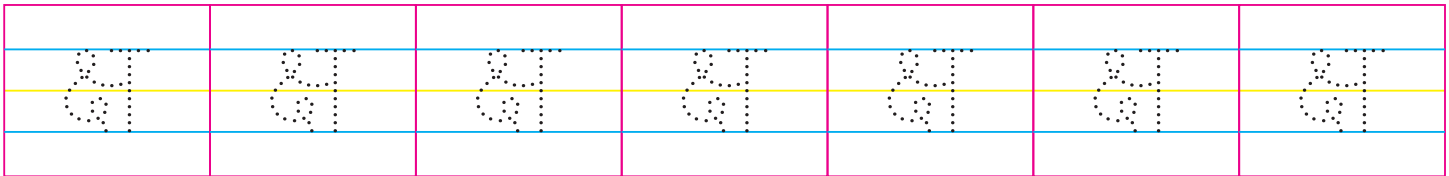
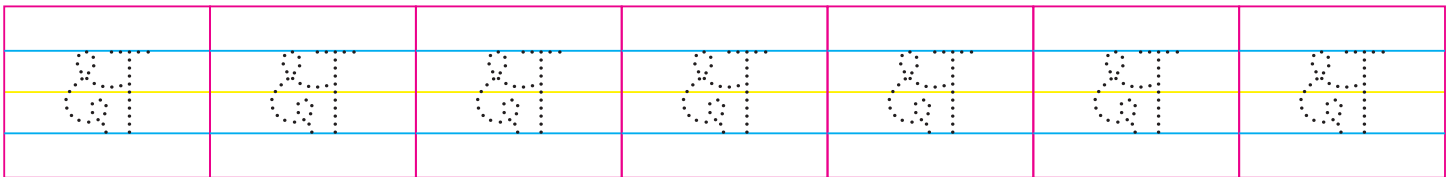
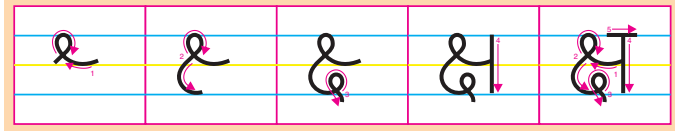

हस्ताक्षर :

दिनांक: ___/___/___

कक्षा कार्य / गृह कार्य

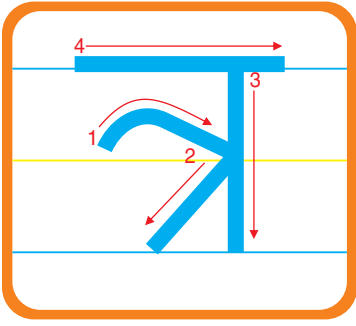

त्रिशूल

चित्र देखकर रंग भरिए-

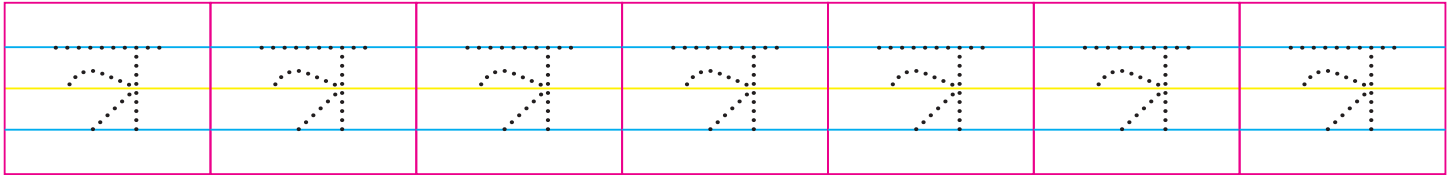
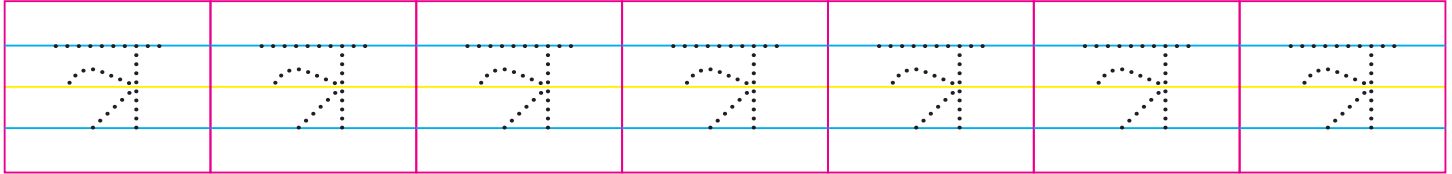
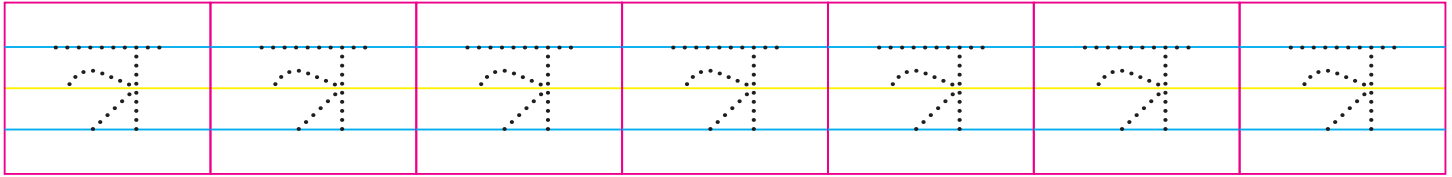
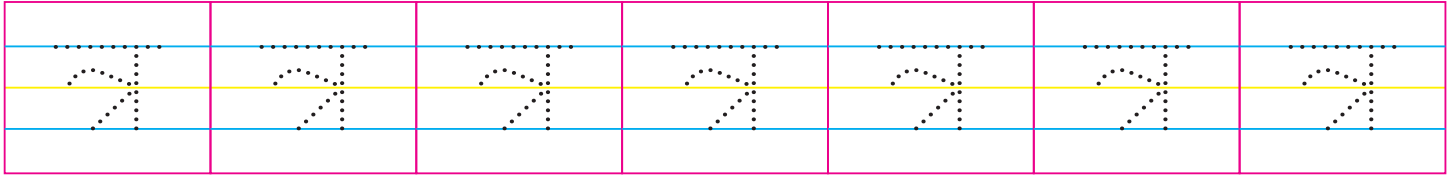
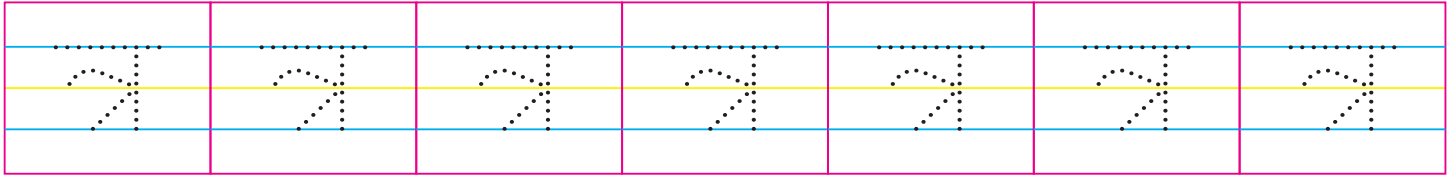
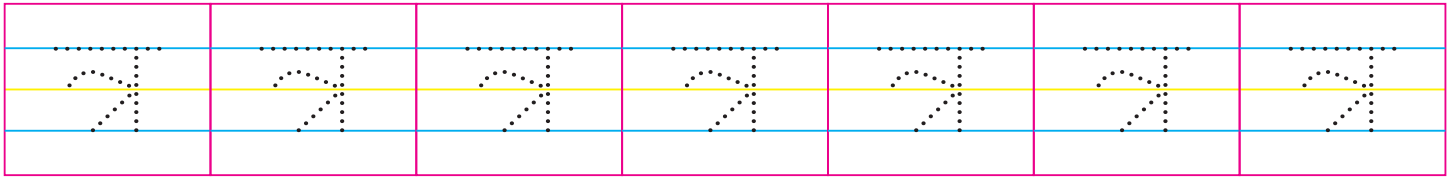
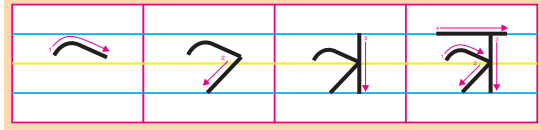

हस्ताक्षर :

दिनांक: ___/___/___

कक्षा कार्य / गृह कार्य

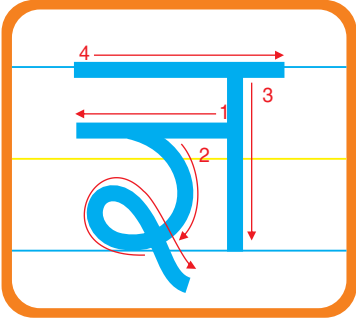

ज्ञानी

चित्र देखकर रंग भरिए-

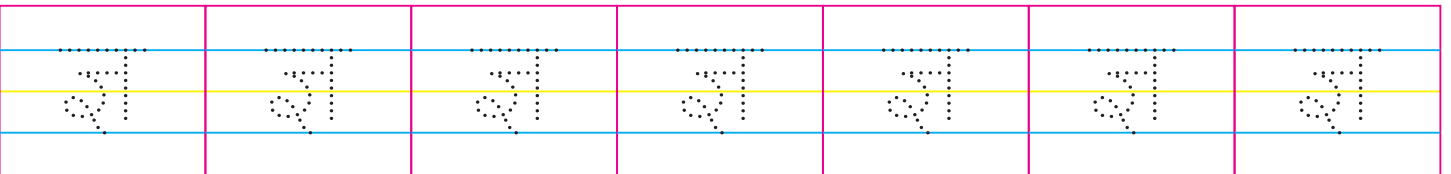
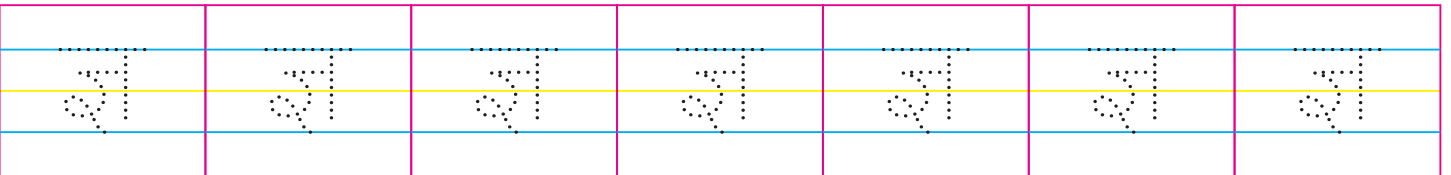
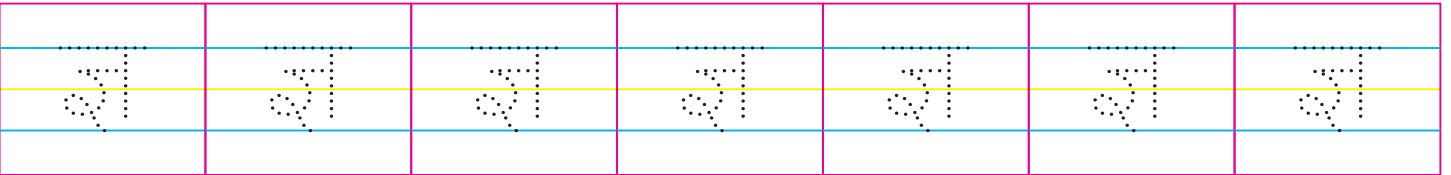
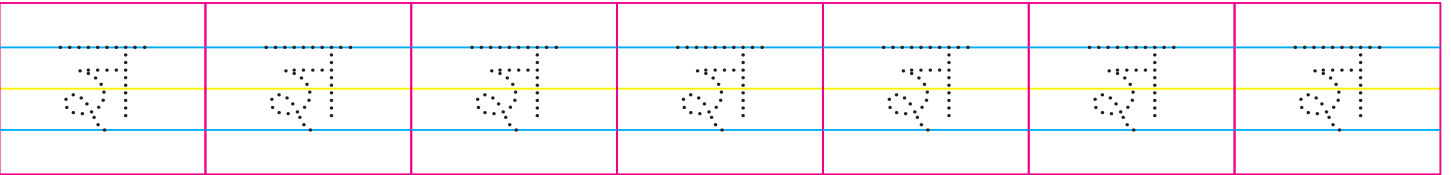
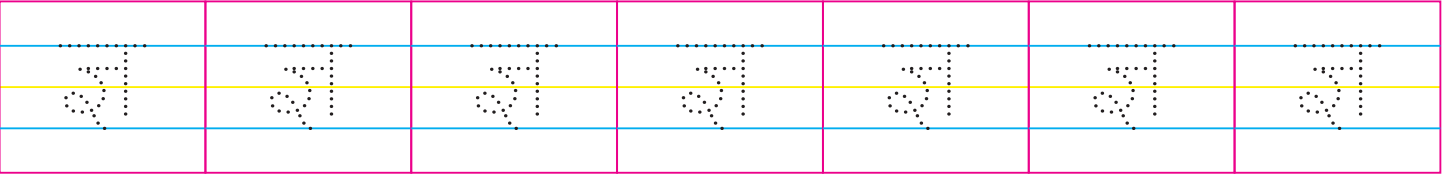
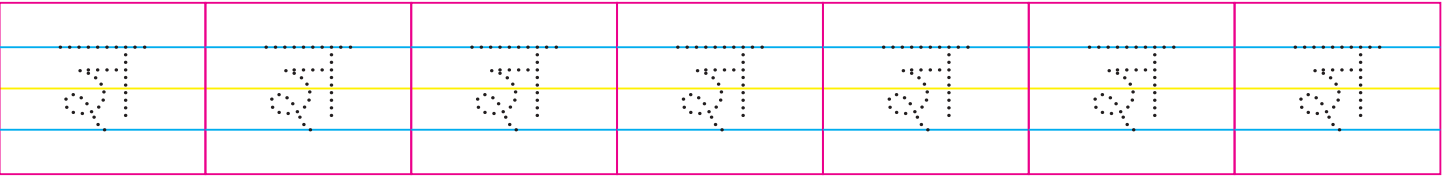
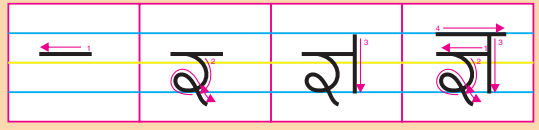

हस्ताक्षर :

दिनांक: ___/___/___

कक्षा कार्य / गृह कार्य

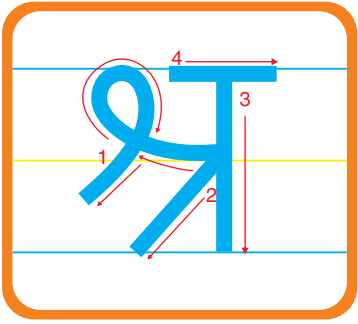

चित्र देखकर रंग भरिए-

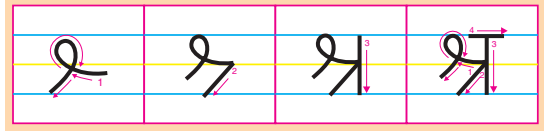

श्रमिक

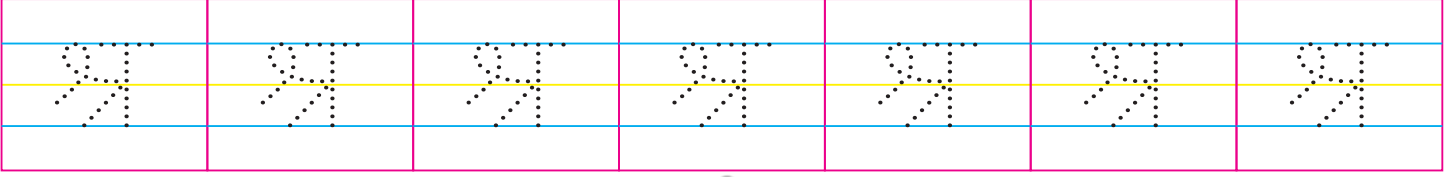
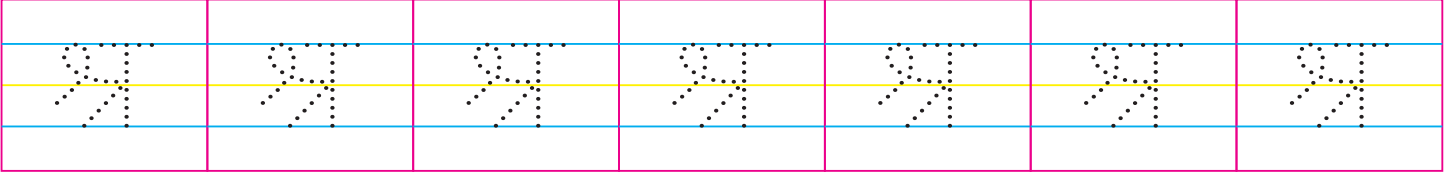
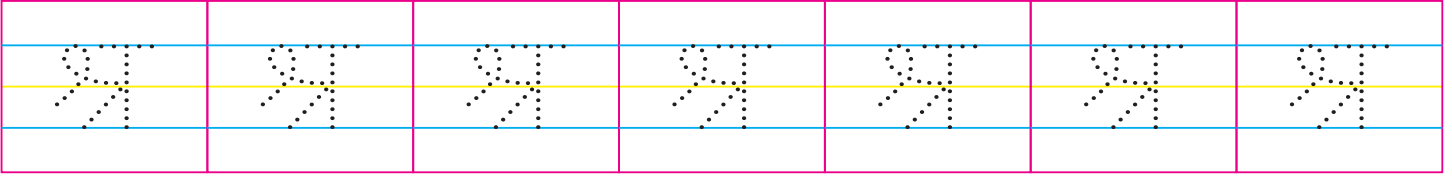
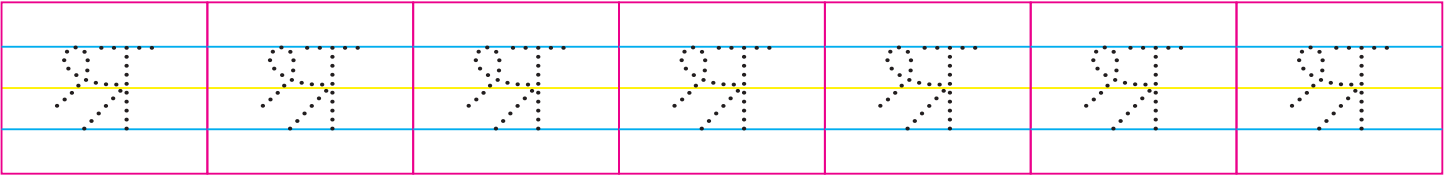
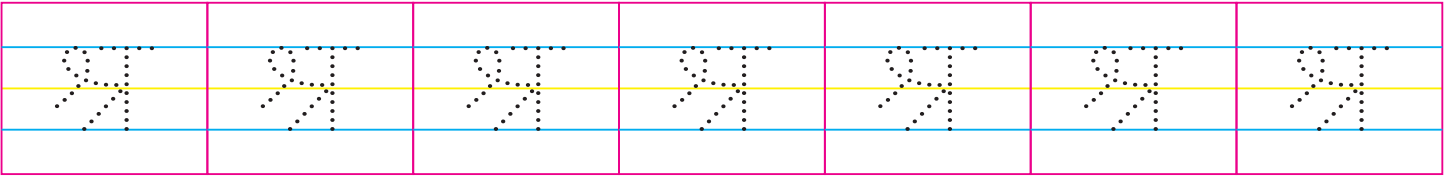
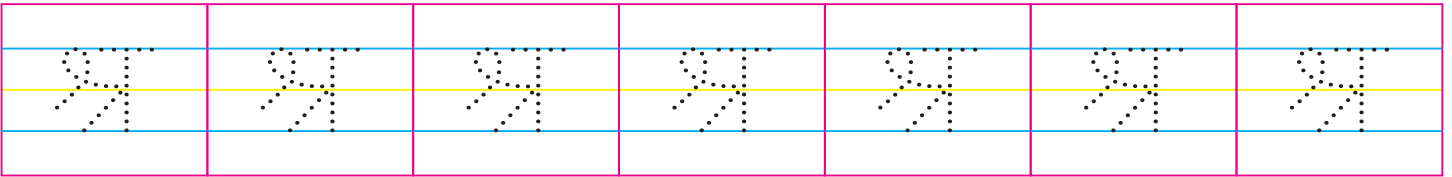

हस्ताक्षर :

दिनांक: ___/___/___

कक्षा कार्य / गृह कार्य

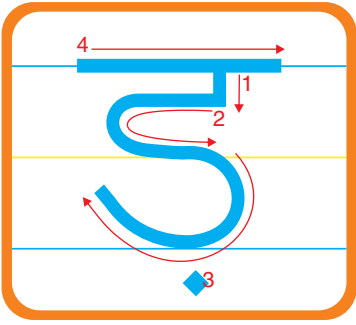

सड़क

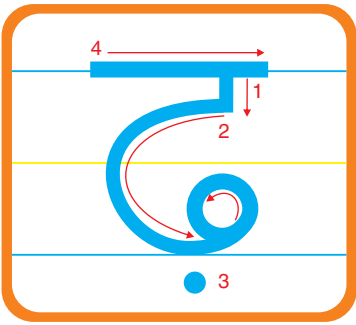
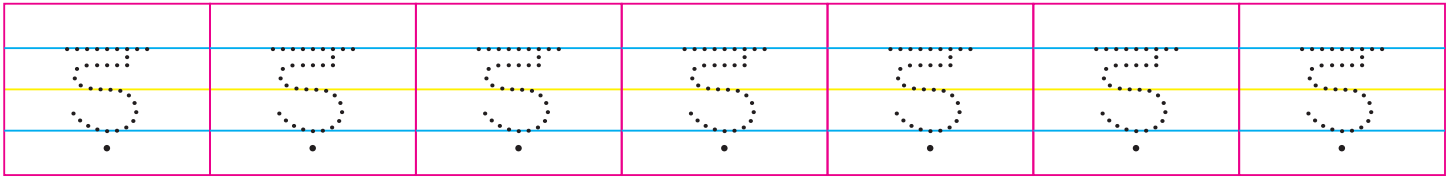
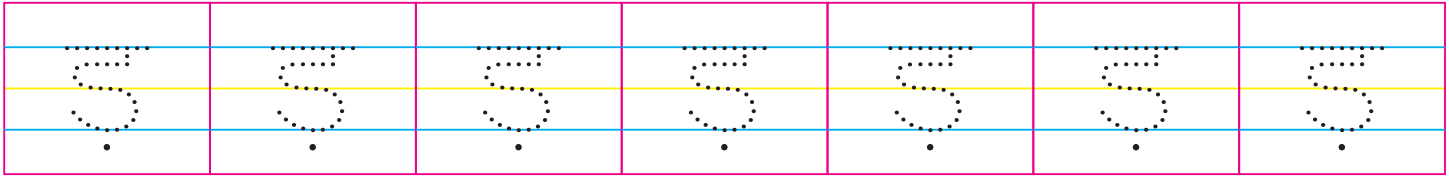
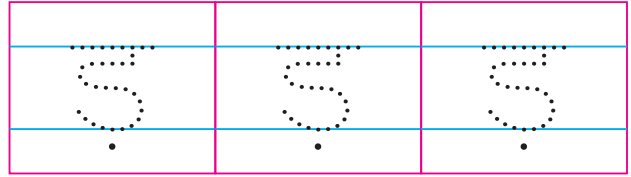
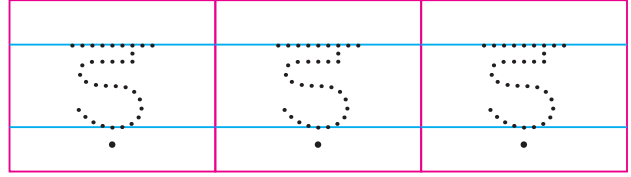
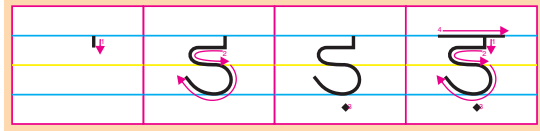

पढ़ना

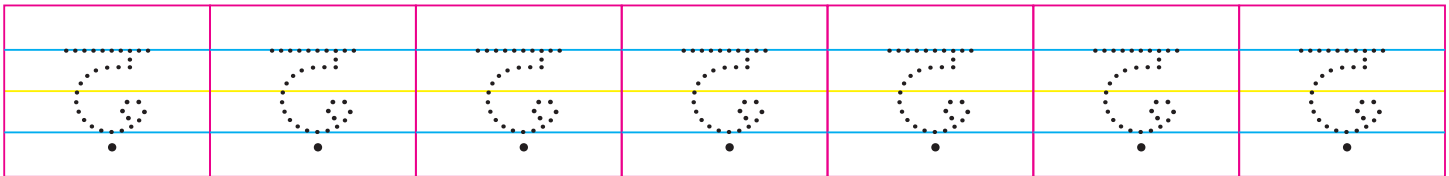
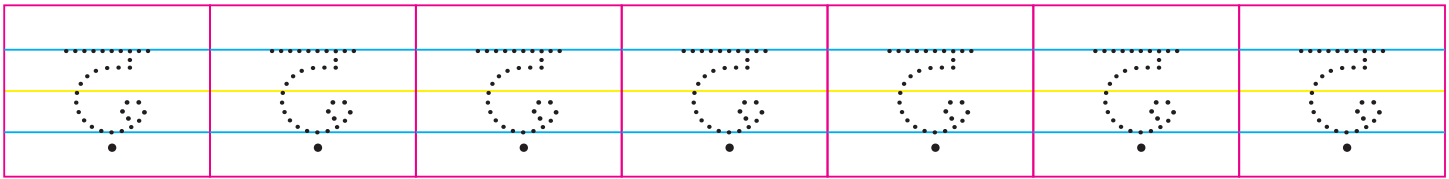
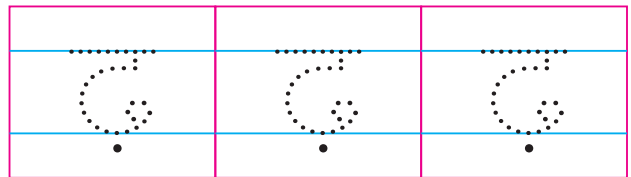
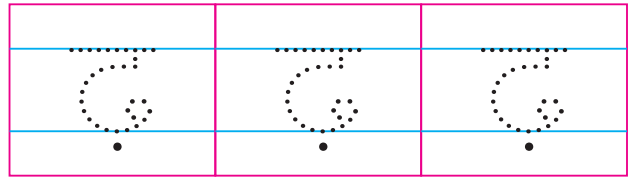
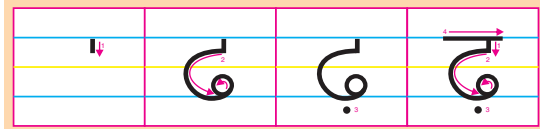

हस्ताक्षर :

दिनांक: ___/___/___

कक्षा कार्य ○ / गृह कार्य ○

अक्षरों को पुनः बोल-बोलकर अभ्यास किजिए और लिखिये:

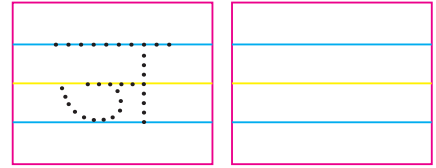
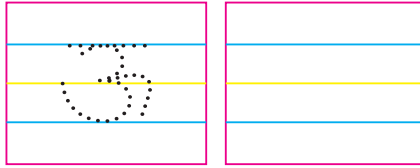
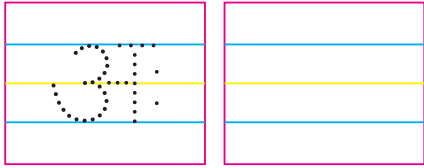
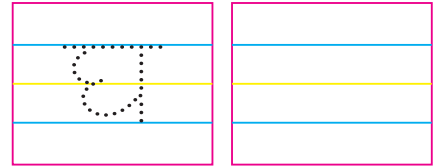
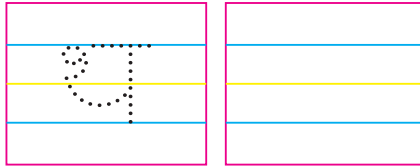
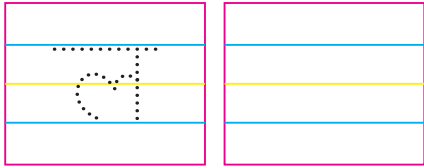
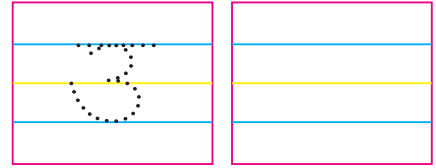
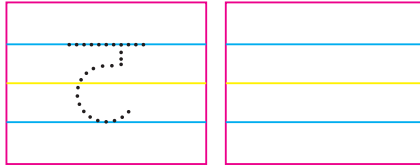
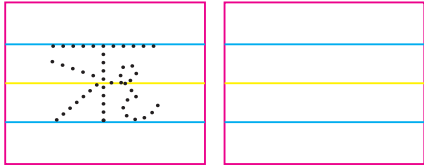
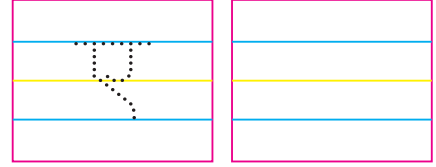
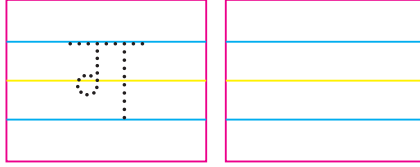
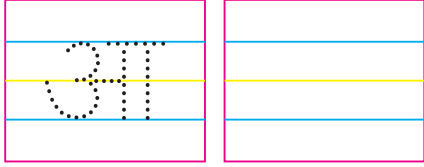
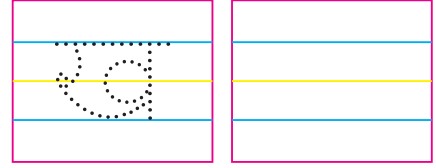
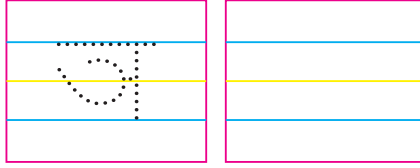
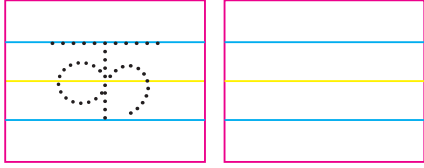

देखो, पढो और लिखो :

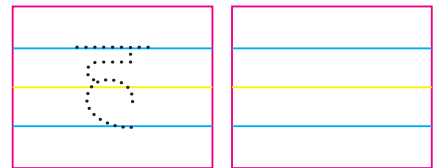
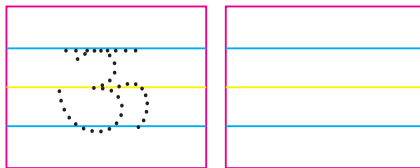
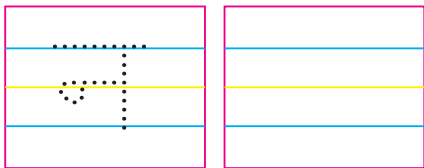
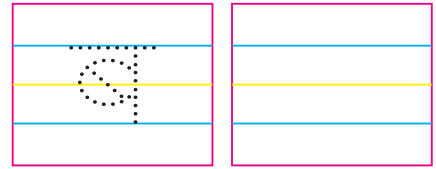
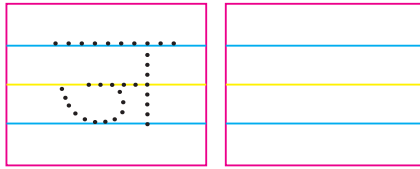
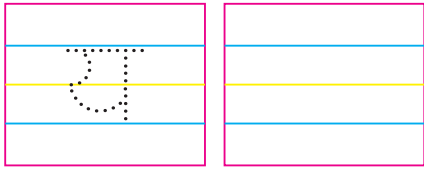

हस्ताक्षर :

दिनांक: ___/___/___

कक्षा कार्य / गृह कार्य

स्वरों का अभ्यास

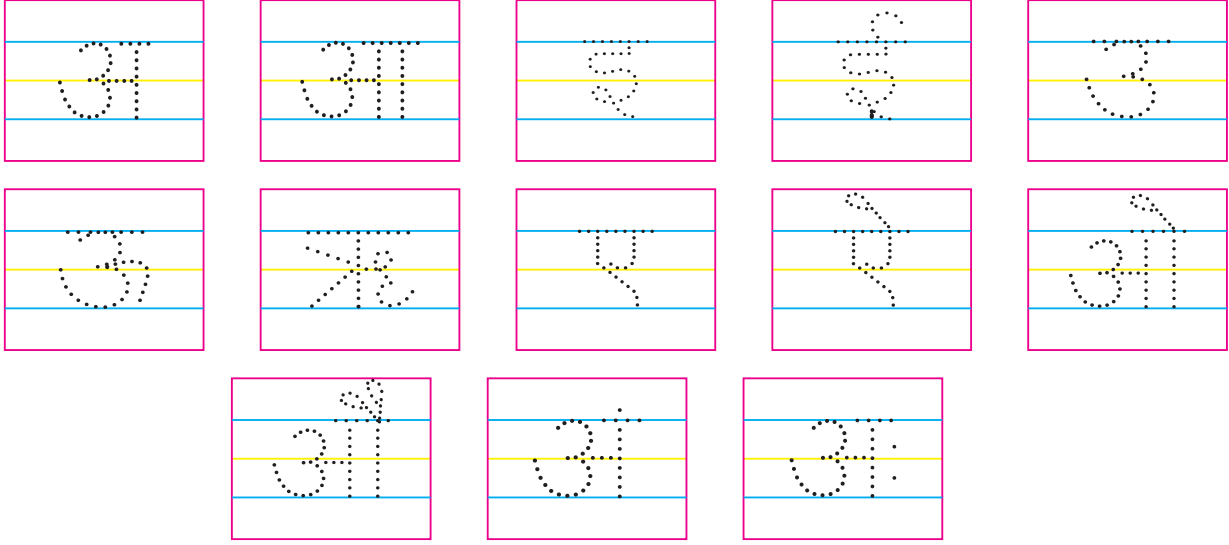

बाद में आने वाले अक्षर लिखें:

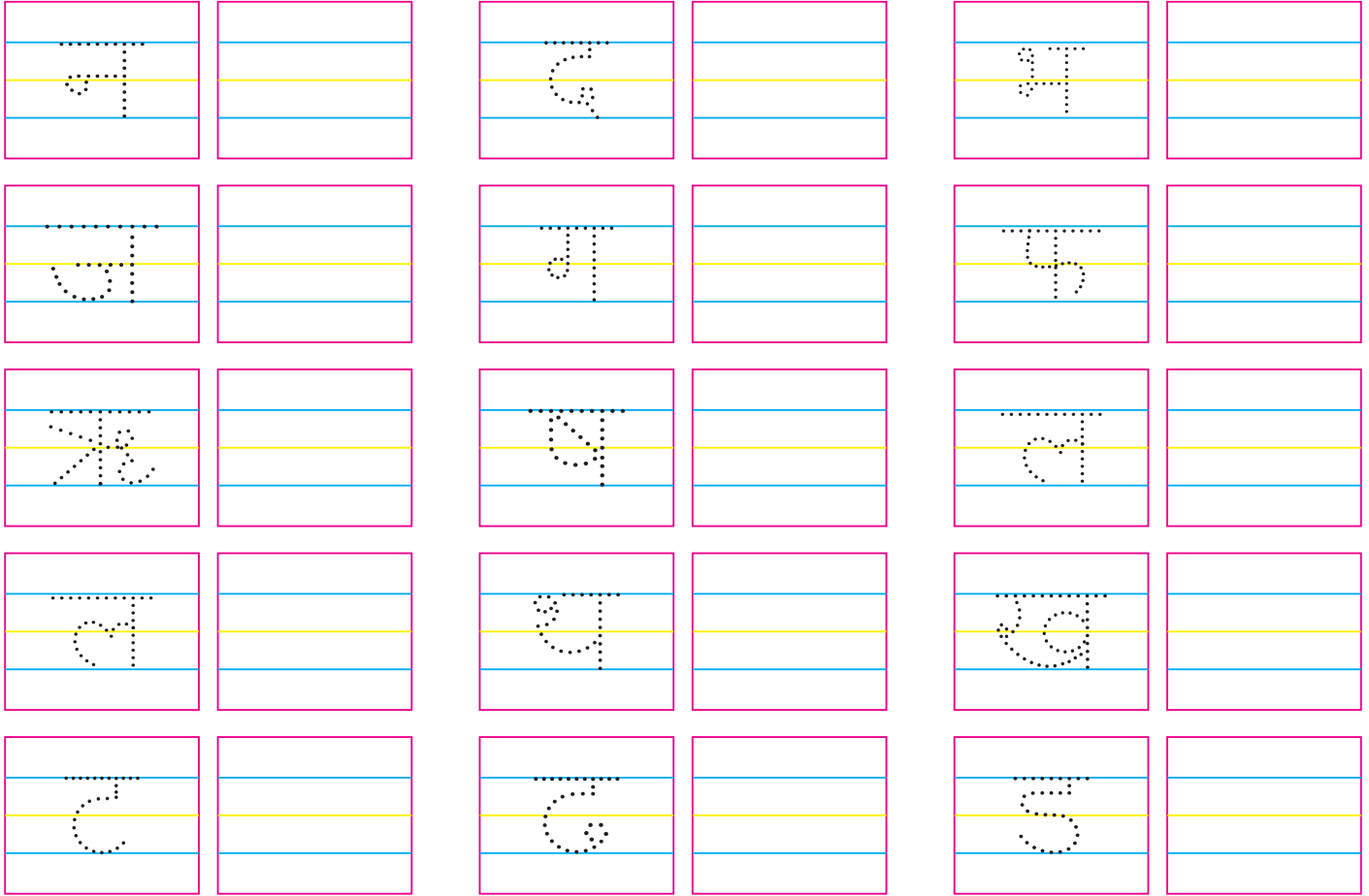

हस्ताक्षर :

दिनांक: ___/___/___

कक्षा कार्य / गृह कार्य

व्यंजनों का अभ्यास

क	ख	ग	घ	ङ
च	छ	ज	झ	ञ
ट	ठ	ड	ढ	ण
त	थ	द	ध	न
प	फ	ब	भ	म
य	र	ल	व	श
ष	स	ह	क्ष	त्र
ज्ञ	श्र	ड़	ड़	

हस्ताक्षर :